

MVME5500
Single-Board Computer

Installation and Use

V5500A/IH2

October 2003 Edition

© Copyright 2003 Motorola Inc.

All rights reserved.

Printed in the United States of America.

Motorola and the stylized M logo are trademarks of Motorola, Inc., registered in the U.S. Patent and Trademark Office.

All other product or service names mentioned in this document are the property of their respective owners.

Safety Summary

The following general safety precautions must be observed during all phases of operation, service, and repair of this equipment. Failure to comply with these precautions or with specific warnings elsewhere in this manual could result in personal injury or damage to the equipment.

The safety precautions listed below represent warnings of certain dangers of which Motorola is aware. You, as the user of the product, should follow these warnings and all other safety precautions necessary for the safe operation of the equipment in your operating environment.

Ground the Instrument.

To minimize shock hazard, the equipment chassis and enclosure must be connected to an electrical ground. If the equipment is supplied with a three-conductor AC power cable, the power cable must be plugged into an approved three-contact electrical outlet, with the grounding wire (green/yellow) reliably connected to an electrical ground (safety ground) at the power outlet. The power jack and mating plug of the power cable meet International Electrotechnical Commission (IEC) safety standards and local electrical regulatory codes.

Do Not Operate in an Explosive Atmosphere.

Do not operate the equipment in any explosive atmosphere such as in the presence of flammable gases or fumes. Operation of any electrical equipment in such an environment could result in an explosion and cause injury or damage.

Keep Away From Live Circuits Inside the Equipment.

Operating personnel must not remove equipment covers. Only Factory Authorized Service Personnel or other qualified service personnel may remove equipment covers for internal subassembly or component replacement or any internal adjustment. Service personnel should not replace components with power cable connected. Under certain conditions, dangerous voltages may exist even with the power cable removed. To avoid injuries, such personnel should always disconnect power and discharge circuits before touching components.

Use Caution When Exposing or Handling a CRT.

Breakage of a Cathode-Ray Tube (CRT) causes a high-velocity scattering of glass fragments (implosion). To prevent CRT implosion, do not handle the CRT and avoid rough handling or jarring of the equipment. Handling of a CRT should be done only by qualified service personnel using approved safety mask and gloves.

Do Not Substitute Parts or Modify Equipment.

Do not install substitute parts or perform any unauthorized modification of the equipment. Contact your local Motorola representative for service and repair to ensure that all safety features are maintained.

Observe Warnings in Manual.

Warnings, such as the example below, precede potentially dangerous procedures throughout this manual. Instructions contained in the warnings must be followed. You should also employ all other safety precautions which you deem necessary for the operation of the equipment in your operating environment.



To prevent serious injury or death from dangerous voltages, use extreme caution when handling, testing, and adjusting this equipment and its components.

Flammability

All Motorola PWBs (printed wiring boards) are manufactured with a flammability rating of 94V-0 by UL-recognized manufacturers.

EMI Caution



This equipment generates, uses and can radiate electromagnetic energy. It may cause or be susceptible to electromagnetic interference (EMI) if not installed and used with adequate EMI protection.

Lithium Battery Caution

This product contains a lithium battery to power the clock and calendar circuitry.



Danger of explosion if battery is replaced incorrectly. Replace battery only with the same or equivalent type recommended by the equipment manufacturer. Dispose of used batteries according to the manufacturer's instructions.



Il y a danger d'explosion s'il y a remplacement incorrect de la batterie. Remplacer uniquement avec une batterie du même type ou d'un type équivalent recommandé par le constructeur. Mettre au rebut les batteries usagées conformément aux instructions du fabricant.



Explosionsgefahr bei unsachgemäßem Austausch der Batterie. Ersatz nur durch denselben oder einen vom Hersteller empfohlenen Typ. Entsorgung gebrauchter Batterien nach Angaben des Herstellers.

CE Notice (European Community)



This is a Class A product. In a domestic environment, this product may cause radio interference, in which case the user may be required to take adequate measures.

Motorola Computer Group products with the CE marking comply with the EMC Directive (89/336/EEC). Compliance with this directive implies conformity to the following European Norms:

EN55022 “Limits and Methods of Measurement of Radio Interference Characteristics of Information Technology Equipment”; this product tested to Equipment Class A

EN55024 “Information technology equipment—Immunity characteristics—Limits and methods of measurement”

Board products are tested in a representative system to show compliance with the above mentioned requirements. A proper installation in a CE-marked system will maintain the required EMC performance.

In accordance with European Community directives, a “Declaration of Conformity” has been made and is available on request. Please contact your sales representative.

Notice

While reasonable efforts have been made to assure the accuracy of this document, Motorola, Inc. assumes no liability resulting from any omissions in this document, or from the use of the information obtained therein. Motorola reserves the right to revise this document and to make changes from time to time in the content hereof without obligation of Motorola to notify any person of such revision or changes.

Electronic versions of this material may be read online, downloaded for personal use, or referenced in another document as a URL to the Motorola Computer Group Web site. The text itself may not be published commercially in print or electronic form, edited, translated, or otherwise altered without the permission of Motorola, Inc.

It is possible that this publication may contain reference to or information about Motorola products (machines and programs), programming, or services that are not available in your country. Such references or information must not be construed to mean that Motorola intends to announce such Motorola products, programming, or services in your country.

Limited and Restricted Rights Legend

If the documentation contained herein is supplied, directly or indirectly, to the U.S. Government, the following notice shall apply unless otherwise agreed to in writing by Motorola, Inc.

Use, duplication, or disclosure by the Government is subject to restrictions as set forth in subparagraph (b)(3) of the Rights in Technical Data clause at DFARS 252.227-7013 (Nov. 1995) and of the Rights in Noncommercial Computer Software and Documentation clause at DFARS 252.227-7014 (Jun. 1995).

Motorola, Inc.
Computer Group
2900 South Diablo Way
Tempe, Arizona 85282

Contents

About This Manual

- Summary of Changesxvii
- Overview of Contents xviii
- Comments and Suggestionsxix
- Conventions Used in This Manualxix

CHAPTER 1 Hardware Preparation and Installation

- Introduction 1-1
- Description 1-1
- Getting Started 1-2
 - Overview of Startup Procedures 1-2
 - Unpacking Guidelines 1-2
- Hardware Configuration 1-3
 - MVME5500 Preparation 1-4
 - Ethernet 2, PMC/SBC Mode, and P2 I/O Selection Headers
(J6, J7, J28, J32, J34, J97 – J110) 1-8
 - Ethernet 1-8
 - PMC/SBC Mode Selection 1-8
 - P2 I/O Selection 1-9
 - Flash Boot Bank Select Header (J8)1-11
 - Flash 0 Programming Enable Header (J9)1-11
 - Safe Start ENV Header (J10) 1-12
 - Flash 0 Block Write Protect Header (J15) 1-12
 - SROM Initialization Enable Header (J17) 1-13
 - PowerPC Bus Mode Select Header (J19) 1-13
 - CPU COP Enable Header (J20) 1-14
 - PCI Bus 0.0 Speed Header (J25) 1-14
 - VME SCON Select Header (J27) 1-15
 - PCI Bus 1.0 Speed Header (J29) 1-15
 - EEPROM Write Protect Header (J30) 1-16
 - Setting the PMC Vio Keying Pin 1-16
- Hardware Installation 1-17
 - Installing the MVME5500 into a Chassis 1-17
- Connection to Peripherals 1-18
- Completing the Installation 1-19

CHAPTER 2 Startup and Operation

Introduction	2-1
Applying Power	2-1
Switches and Indicators	2-1

CHAPTER 3 MOTLoad Firmware

Introduction	3-1
Overview	3-1
MOTLoad Implementation and Memory Requirements	3-1
MOTLoad Commands	3-2
MOTLoad Utility Applications	3-2
MOTLoad Tests	3-2
Using MOTLoad	3-4
Command Line Interface	3-4
Command Line Help	3-5
Command Line Rules	3-6
MOTLoad Command List	3-7
VME Settings	3-12
CR/CSR Settings	3-16
Displaying VME Settings	3-16
Editing VME Settings	3-17
Deleting VME Settings	3-18
Restoring Default VME Settings	3-18
Remote Start	3-19

CHAPTER 4 Functional Description

Features	4-1
Block Diagram	4-2
Processor	4-3
L3 Cache	4-3
System Controller	4-4
CPU Bus Interface	4-4
Memory Controller Interface	4-5
Interrupt Controller	4-5
I2C Serial Interface and Devices	4-5
Direct Memory Access (DMA)	4-6
Timers	4-6
Flash Memory	4-7

System Memory	4-7
PCI Local Buses and Devices	4-8
Gigabit Ethernet Interface	4-8
10/100Mb Ethernet Interface	4-8
PCI-to-PCI Bridges	4-9
PMC Sites	4-9
PCI IDSEL Definition	4-9
PCI Bus Arbitration	4-9
Asynchronous Serial Ports	4-10
Real Time Clock and NVRAM	4-10
System Control and Status Registers	4-11
Sources of Reset	4-11
VME Interface	4-11
PMC Expansion	4-12
Debug Support	4-12

CHAPTER 5 Pin Assignments

Introduction	5-1
Connectors	5-2
Asynchronous Serial Port Connector (J1)	5-2
Ethernet Connectors (J2)	5-3
IPMC Connector (J3)	5-3
PCI/PMC Expansion Connector (J4)	5-5
CPU COP Connector (J5)	5-8
PMC 1 Interface Connectors (J11, J12, J13, J14)	5-8
Boundary Scan Connector (J18)	5-15
PMC 2 Interface Connectors (J21, J22, J23, J24)	5-16
Asynchronous Serial Port (COM2) Planar Connector (J33)	5-22
VMEbus Connectors (P1 & P2) (PMC Mode)	5-22
VMEbus Connectors (P1 & P2) (SBC Mode)	5-25
Memory Expansion Connector (P4)	5-29
Headers	5-33
Ethernet 2, PMC/SBC Mode, and P2 I/O Selection Headers	
(J6, J7, J28, J32, J34, J97 – J110)	5-33
Ethernet	5-33
PMC/SBC Mode Selection	5-34
P2 I/O Selection	5-35
Flash Boot Bank Select Header (J8)	5-40
Flash 0 Programming Enable Header (J9)	5-40
Safe Start ENV Header (J10)	5-41

Flash 0 Block Write Protect Header (J15)	5-41
SROM Initialization Enable Header (J17)	5-42
Bus Mode Select Header (J19)	5-42
COP Enable Header (J20)	5-43
PCI Bus 0.0 Speed Header (J25)	5-43
VME SCON Select Header (J27)	5-44
PCI Bus 1.0 Speed Header (J29)	5-44
EEPROM Write Protect Header (J30)	5-45

APPENDIX A Specifications

Power Requirements	A-1
Supply Current Requirements	A-1
Environmental Specifications	A-2

APPENDIX B RAM5500 Memory Expansion Module

Overview	B-1
Features	B-1
Functional Description	B-1
RAM5500 Description	B-1
SROM	B-3
Clocks	B-3
RAM5500 Module Installation	B-3
Memory Expansion Connector (P1) Pin Assignments	B-5
RAM5500 Programming Issues	B-8
Serial Presence Detect (SPD) Data	B-8

APPENDIX C Thermal Validation

Thermally Significant Components	C-1
Component Temperature Measurement	C-5
Preparation	C-5
Measuring Junction Temperature	C-5
Measuring Case Temperature	C-5
Measuring Local Air Temperature	C-8

APPENDIX D Related Documentation

Motorola Computer Group DocumentsD-1
Manufacturers' DocumentsD-2
Related SpecificationsD-5

List of Figures

Figure 1-1. MVME5500 Layout	1-7
Figure 4-1. MVME5500 Block Diagram	4-3
Figure 4-2. COM1 Asynchronous Serial Port Connections (RJ-45)	4-10
Figure 5-1. SBC/IPMC712 Mode	5-37
Figure 5-2. SBC/IPMC761 Mode	5-38
Figure 5-3. PMC Mode	5-39
Figure B-1. RAM5500 Block Diagram	B-2
Figure C-1. Thermally Significant Components—Primary Side	C-3
Figure C-2. Thermally Significant Components—Secondary Side	C-4
Figure C-3. Mounting a Thermocouple Under a Heatsink	C-7
Figure C-4. Measuring Local Air Temperature	C-8

List of Tables

Table 1-1. Startup Overview	1-2
Table 1-2. MVME5500 Jumper Settings	1-5
Table 1-3. MVME5500 Connectors	1-18
Table 2-1. Front-Panel LED Status Indicators	2-2
Table 3-1. MOTLoad Commands	3-7
Table 4-1. MVME5500 Features Summary	4-1
Table 5-1. COM1 Connector (J1) Pin Assignments	5-2
Table 5-2. Ethernet Connector (J2) Pin Assignments	5-3
Table 5-3. IPMC Connector (J3) Pin Assignments	5-3
Table 5-4. PCI/PMC Expansion Connector (J4) Pin Assignments	5-5
Table 5-5. CPU COP Connector (J5) Pin Assignments	5-8
Table 5-6. PMC 1 Connector (J11) Pin Assignments	5-9
Table 5-7. PMC 1 Connector (J12) Pin Assignments	5-10
Table 5-8. PMC 1 Connector (J13) Pin Assignments	5-12
Table 5-9. PMC 1 Connector (J14) Pin Assignments	5-13
Table 5-10. Boundary Scan Connector (J18) Pin Assignments	5-15
Table 5-11. PMC 2 Connector (J21) Pin Assignments	5-16
Table 5-12. PMC 2 Connector (J22) Pin Assignments	5-17
Table 5-13. PMC 2 Connector (J23) Pin Assignments	5-19
Table 5-14. PMC 2 Connector (J24) Pin Assignments	5-20
Table 5-15. COM2 Planar Connector (J33) Pin Assignments	5-22
Table 5-16. VME Connector (P2) Pin Assignments (PMC Mode)	5-23
Table 5-17. VME Connector (P2) Pinout with IPMC712	5-26
Table 5-18. VME Connector (P2) Pinouts with IPMC761	5-27
Table 5-19. Memory Expansion Connector (P4) Pin Assignments	5-29
Table 5-20. Ethernet 2 Selection Headers (J6, J7, J100, J101) Pin Assignments ..	5-33
Table 5-21. Ethernet 2 Selection Headers (J34, J97, J98, J99) Pin Assignments ..	5-34
Table 5-22. PMC/SBC Mode Selection Headers (J28, J32) Pin Assignments	5-35
Table 5-23. P2 I/O Selection Headers (J102 – J110) Pin Assignments	5-36
Table 5-24. Flash Boot Bank Select Header (J8) Pin Assignments	5-40
Table 5-25. Flash 0 Programming Enable Header (J9) Pin Assignments	5-40
Table 5-26. Safe Start ENV Header (J10) Pin Assignments	5-41
Table 5-27. Flash 0 Write Protect Header (J15) Pin Assignments	5-41
Table 5-28. SROM Initialization Enable Header (J17) Pin Assignments	5-42

Table 5-29. Bus Mode Header (J19) Pin Assignments	5-42
Table 5-30. COP Enable Header (J20) Pin Assignments	5-43
Table 5-31. PCI Bus 0.0 Speed Header (J25) Pin Assignments	5-43
Table 5-32. VME SCON Select Header (J27) Pin Assignments	5-44
Table 5-33. PCI Bus 1.0 Speed Header (J25) Pin Assignments	5-44
Table 5-34. EEPROM Write Protect Header (J30) Pin Assignments	5-45
Table A-1. Power Requirements	A-1
Table A-2. MVME5500 Specifications	A-2
Table B-1. RAM5500 Feature Summary	B-1
Table B-2. RAM5500 Connector (P1) Pin Assignments	B-5
Table C-1. Thermally Significant Components	C-2
Table D-1. Motorola Computer Group Documents	D-1
Table D-2. Manufacturers' Documents	D-2
Table D-3. Related Specifications	D-5

About This Manual

The *MVME5500 Single-Board Computer Installation and Use* manual provides the information you will need to install and configure your MVME5500 single-board computer. It provides specific preparation and installation information, and data applicable to the board.

As of the printing date of this manual, the MVME5500 supports the models listed below.

Model Number	Description
MVME5500-0161	1 GHz MPC7455 processor, 512MB SDRAM, Scanbe handles
MVME5500-0163	1 GHz MPC7455 processor, 512MB SDRAM, IEEE handles

Summary of Changes

This is the second edition of the *Installation and Use* manual. It supersedes the August 2003 edition and incorporates the following changes.

Date	Changes
October 2003	Added diagrams to <i>Ethernet 2, PMC/SBC Mode, and P2 I/O Selection Headers (J6, J7, J28, J32, J34, J97 – J110)</i> on page 5-33 to better explain the PMC, SBC/IPMC761, and SBC/IPMC712 modes in conjunction with the P2 adapter and MVME761/712 transition modules. Added Appendix B, RAM5500 Memory Expansion Module . Changed the default configuration of the <i>Flash Boot Bank Select Header (J8)</i> to Flash device 0. Added LFM specification to Table A-2 on page A-2 . Added more details to VME Settings on page 3-12 . Other changes were made to correct typographical errors.

Overview of Contents

This manual is divided into the following chapters and appendices:

[Chapter 1, *Hardware Preparation and Installation*](#), provides MVME5500 board preparation and installation instructions, as well as ESD precautionary notes.

[Chapter 2, *Startup and Operation*](#), provides the power-up procedure and identifies the switches and indicators on the MVMEM5500.

[Chapter 3, *MOTLoad Firmware*](#), describes the basic features of the MOTLoad firmware product.

[Chapter 4, *Functional Description*](#), describes the MVME5500 on a block diagram level.

[Chapter 5, *Pin Assignments*](#), provides pin assignments for various headers and connectors on the MMVE5500 single-board computer.

[Appendix A, *Specifications*](#), provides power requirements and environmental specifications.

[Appendix B, *RAM5500 Memory Expansion Module*](#), provides a description of the RAM5500 memory expansion module, as well as installation instructions and connector pin assignments.

[Appendix C, *Thermal Validation*](#), provides information to conduct thermal evaluations and identifies thermally significant components along with their maximum allowable operating temperatures.

[Appendix D, *Related Documentation*](#), provides a listing of related Motorola manuals, vendor documentation, and industry specifications.

Comments and Suggestions

Motorola welcomes and appreciates your comments on its documentation. We want to know what you think about our manuals and how we can make them better. Mail comments to:

Motorola Computer Group
Reader Comments DW164
2900 S. Diablo Way
Tempe, Arizona 85282

You can also submit comments to the following e-mail address:
reader-comments@mcg.mot.com

In all your correspondence, please list your name, position, and company. Be sure to include the title and part number of the manual and tell how you used it. Then tell us your feelings about its strengths and weaknesses and any recommendations for improvements.

Conventions Used in This Manual

The following typographical conventions are used in this document:

bold

is used for user input that you type just as it appears; it is also used for commands, options and arguments to commands, and names of programs, directories and files.

italic

is used for names of variables to which you assign values, for function parameters, and for structure names and fields. Italic is also used for comments in screen displays and examples, and to introduce new terms.

`courier`

is used for system output (for example, screen displays, reports), examples, and system prompts.

<Enter>, <Return> or <CR>

represents the carriage return or Enter key.

Ctrl

represents the Control key. Execute control characters by pressing the Ctrl key and the letter simultaneously, for example, Ctrl-d.

Hardware Preparation and Installation

1

Introduction

This chapter contains the following information:

- ❑ Board preparation and installation instructions
- ❑ ESD precautionary notes

Description

The MVME5500 is a single-board computer based on the PowerPC MPC7455 processor and the Marvell GT-64260B host bridge with a dual PCI interface and memory controller. On-board payload includes two PMC slots, two SDRAM banks, an expansion connector for two additional banks of SDRAM, 8MB boot Flash ROM, one 10/100/1000 Ethernet port, one 10/100 Ethernet port, 32MB expansion Flash ROM, two serial ports, NVRAM and a real-time clock.

The MVME5500 interfaces to a VMEbus system via its P1 and P2 connectors and contains two IEEE 1386.1 PCI mezzanine card (PMC) slots. The PMC slots are 64-bit and support both front and rear I/O.

Additionally, the MVME5500 is user-configurable by setting on-board jumpers. Two I/O modes are possible: PMC mode or SBC mode (also called 761 or IPMC mode). The SBC mode uses the IPMC712 I/O PMC and the MVME712M transition module, or the IPMC761 I/O PMC and the MVME761 transition module. The SBC mode is backwards compatible with the MVME761 transition module and the P2 adapter card (excluding PMC I/O routing) used on the MVME5100 product. This mode is accomplished by configuring the on-board jumpers and by attaching an IPMC761 PMC in PMC slot 1. Secondary Ethernet is configured to the rear.

PMC mode is backwards compatible with the MVME5100 and is accomplished by configuring the on-board jumpers.

Getting Started

This section provides an overview of the steps necessary to install and power up the MVME5500 and a brief section on unpacking and ESD precautions.

Overview of Startup Procedures

The following table lists the things you will need to do before you can use this board and tells where to find the information you need to perform each step. Be sure to read this entire chapter, including all Caution and Warning notes, before you begin.

Table 1-1. Startup Overview

What you need to do...	Refer to...
Unpack the hardware.	<i>Unpacking Guidelines</i> on page 1-2
Configure the hardware by setting jumpers on the board.	<i>MVME5500 Preparation</i> on page 1-4
Install the MVME5500 board in a chassis.	<i>Installing the MVME5500 into a Chassis</i> on page 1-17
Connect any other equipment you will be using	<i>Connection to Peripherals</i> on page 1-18
Verify the hardware is installed.	<i>Completing the Installation</i> on page 1-19

Unpacking Guidelines

Unpack the equipment from the shipping carton. Refer to the packing list and verify that all items are present. Save the packing material for storing and reshipping of equipment.

Note If the shipping carton is damaged upon receipt, request that the carrier's agent be present during the unpacking and inspection of the equipment.



Avoid touching areas of integrated circuitry; static discharge can damage circuits.

Use ESD

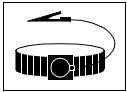

Motorola strongly recommends that you use an antistatic wrist strap and a conductive foam pad when installing or upgrading a system. Electronic components, such as disk drives, computer boards, and memory modules can be extremely sensitive to electrostatic discharge (ESD). After removing the component from its protective wrapper or from the system, place the component flat on a grounded, static-free surface (and, in the case of a board, component side up). Do not slide the component over any surface.

If an ESD station is not available, you can avoid damage resulting from ESD by wearing an antistatic wrist strap (available at electronics stores) that is attached to an active electrical ground. Note that a system chassis may not be grounded if it is unplugged.



Inserting or removing modules with power applied may result in damage to module components.



Dangerous voltages, capable of causing death, are present in this equipment. Use extreme caution when handling, testing, and adjusting.

Hardware Configuration

This section discusses certain hardware and software tasks that may need to be performed prior to installing the board in a chassis.

To produce the desired configuration and ensure proper operation of the MVME5500, you may need to carry out certain hardware modifications before installing the module.

Most options on the MVME5500 are software configurable. Configuration changes are made by setting bits in control registers after the board is installed in a system.

Jumpers are used to control those options that are not software configurable. These jumper settings are described further on in this section. If you are resetting the board jumpers from their default settings, it is important to verify that all settings are reset properly.

MVME5500 Preparation

[Figure 1-1](#) illustrates the placement of the jumpers, headers, connectors, and various other components on the MVME5500. There are several manually configurable headers on the MVME5500 and their settings are shown in [Table 1-2](#). Each header's default setting is enclosed in brackets.

For pin assignments on the MVME5500, refer to [Chapter 5, Pin Assignments](#).

Table 1-2. MVME5500 Jumper Settings

Jumper	Function	Settings	
J6, J100, J7, J101	Ethernet 2 Selection Headers (see also J34, J97, J98, J99) Note Refer to the note on page 1-8 for a configuration limitation.	2-3 on all [1-2 on all]	Rear P2 Ethernet (SBC mode) Front-panel Ethernet
J8	Flash Boot Bank Select Header	No jumper installed [1-2] 2-3	Boots from Flash 0 Boots from Flash 0 Boots from Flash 1
J9	Flash 0 Programming Enable Header	No jumper installed [1-2]	Disables Flash 0 writes Enables Flash 0 writes
J10	Safe Start ENV Header	No jumper installed [1-2] 2-3	Normal ENV settings used during boot Normal ENV settings used during boot Safe ENV settings used during boot
J15	Flash 0 Block Write Protect Header	No jumper installed [1-2]	Disables Flash 0 K3 block writes Enables Flash 0 K3 block writes
J16	Non-Standard Option Header	For factory use only.	
J17	SROM Initialization Enable Header	No jumper installed [1-2] 2-3	Enables SROM initialization Enables SROM initialization Disables SROM initialization
J19	PowerPC Bus Mode Select Header	No jumper installed [1-2] 2-3	60x bus mode 60x bus mode MPX bus mode

Table 1-2. MVME5500 Jumper Settings (continued)

Jumper	Function	Settings	
J20	CPU COP Enable Header	No jumper installed [1-2]	Enables boundary scan Enables CPU COP
J25	PCI Bus 0.0 Speed Header	[No jumper installed] 1-2	PMC board controls whether the bus runs at 33 MHz or 66 MHz Forces PCI bus 0.0 to remain at 33 MHz
J27	VME SCON Select Header	No jumper installed 1-2 [2-3]	Always SCON No SCON Auto-SCON
J28, J32	PMC/SBC Mode Selection Headers (set both jumpers) Warning: Refer to page 1-9 for a warning about configuring for IPMC mode.	1-2 on both 2-3 on both [2-3 on J32, 1-2 on J28]	PMC mode SBC/IPMC761 mode SBC/IPMC712 mode
J29	PCI Bus 1.0 Speed Header	[No jumper installed] 1-2	PMC board controls whether the bus runs at 33 MHz or 66 MHz Forces PCI bus 1.0 to remain at 33 MHz
J30	EEPROM Write Protect Header	No jumper installed [1-2]	Disables EEPROM programming Enables EEPROM programming
J34, J97, J98, J99	Ethernet 2 Selection Headers (see also J6, J100, J7, J101) Note Refer to a note on page 1-8 for a configuration limitation.	1-2 on all	Rear P2 Ethernet (set when in SBC/IPMC761 mode)
		[No jumpers installed]	Front-panel Ethernet
J102 – J110	P2 I/O Selection Headers	1-2 [2-3]	PMC 2 I/O connected to P2 IPMC I/O connected to P2

Note Items in brackets are factory default settings.

The MVME5500 is factory tested and shipped with the configuration described in the following section.

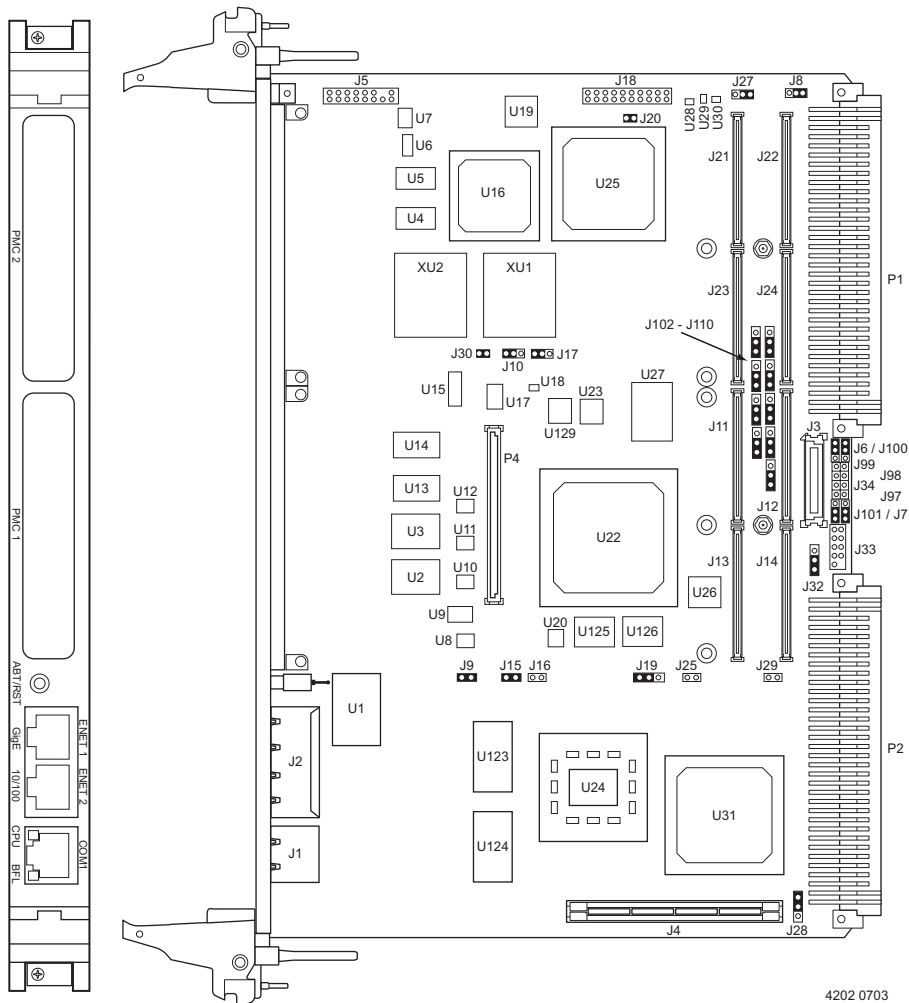

Figure 1-1. MVME5500 Layout

Ethernet 2, PMC/SBC Mode, and P2 I/O Selection Headers (J6, J7, J28, J32, J34, J97 – J110)

All of the headers described below are used in conjunction with each other to select various modes of operation for 10/100BaseT Ethernet, PMC/SBC mode, and P2 I/O mode.

Ethernet

Four 3-pin planar headers (J6, J7, J100, J101) and four 2-pin planar headers (J34, J97, J98, J99) are for 10/100/BaseT Ethernet 2 selection. *Ethernet 1 is the Gigabit Ethernet port and is front panel only.*

For J6, J100, J7 and J101, install jumpers across pins 2-3 on all four headers for rear P2 Ethernet. For front-panel Ethernet, install jumpers across pins 1-2 on all four headers.

Note If the rear P2 Ethernet is selected by jumpers J6, J7, J100, and J101, the Ethernet signals also connect to PMC 1 user I/O connector J14. If a PMC card is plugged into PMC slot 1, there may be a conflict between the I/O from the PMC card and the rear Ethernet signals. This conflict does not occur with the IPMC761 or IPMC712 modules.

For J34, J97, J98 and J99, no jumpers are installed for front-panel Ethernet. For rear P2 Ethernet, install jumpers across pins 1-2 on all four headers when in SBC/IPMC761 mode.

PMC/SBC Mode Selection

The MVME5500 is set at the factory for SBC/IPMC712 mode. The SBC/IPMC761 mode should only be selected when using the IPMC761 module in conjunction with the MVME761 transition module. The PMC mode should be selected when using PMC modules with specific user I/O in conjunction with the corresponding transition module. PMC mode should also be selected when using PrPMC modules.

Two 3-pin planar headers (J28, J32) are for PMC/SBC mode selection. For PMC mode, install jumpers across pins 1-2 on both headers. For SBC/IPMC761 mode, install jumpers across pins 2-3 on both headers. For

SBC/IPMC712 mode, install a jumper across pins 2-3 for J32 and install a jumper across pins 1-2 for J28.



When J28 is configured for SBC/IPMC mode, -12V is supplied to P2 pin A30. If there is an incompatible board plugged into this P2 slot, damage may occur.

When J32 is configured for SBC/IPMC mode, +12V is supplied to P2 pin C7. If there is an incompatible board plugged into this P2 slot, damage may occur.

P2 I/O Selection

Nine 3-pin planar headers (J102 –J110) are for P2 I/O selection. Install jumpers across pins 1-2 on all nine headers when in PMC mode. Install jumpers across pins 2-3 on all nine headers when in SBC/IPMC761 or SBC/IPMC712 mode to connect the extended SCSI signals to P2.

Rear P2 Ethernet

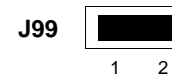
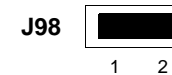
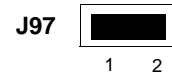
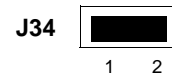
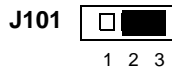
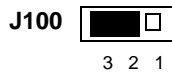
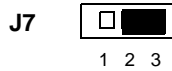
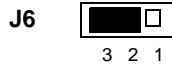

(factory configuration)
Front-Panel Ethernet

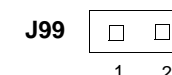
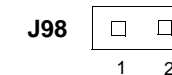
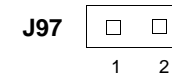
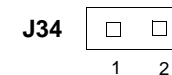
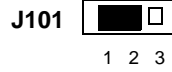
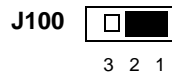
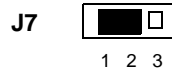
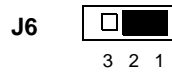

PMC Mode

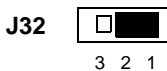
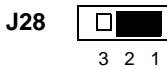

SBC/IPMC761 Mode

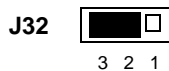
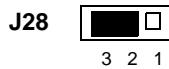

(factory configuration)
SBC/IPMC712 Mode

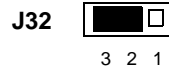
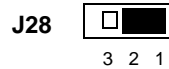

P2 PMC 2 I/O

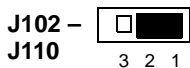

(factory configuration)
(extended SCSI)
P2 IPMC I/O

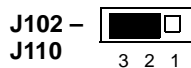

Flash Boot Bank Select Header (J8)

A 3-pin planar header selects the boot Flash bank. No jumper or a jumper installed across pins 1-2 selects Flash 0 as the boot bank. A jumper installed across pins 2-3 selects Flash 1 as the boot bank.

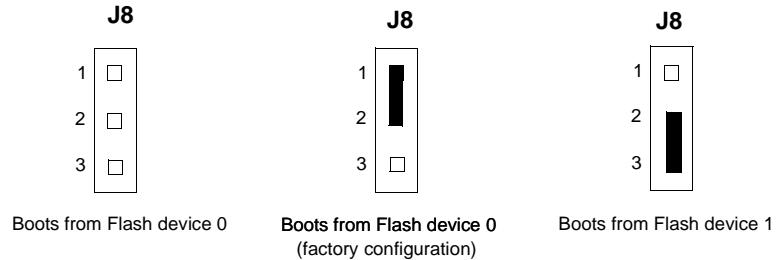

Flash 0 Programming Enable Header (J9)

A 2-pin planar header enables/disables programming of Flash 0 as a means of protecting the contents from being corrupted. No jumper installed disables all Flash 0 programming. The jumper must be installed in order to erase array blocks, programming data, or configuring lock-bits.

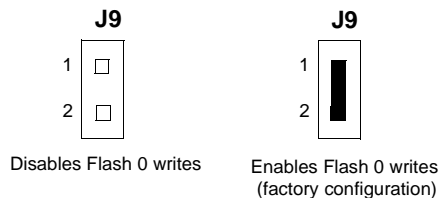

Safe Start ENV Header (J10)

A 3-pin planar header selects programmed or safe start ENV settings. No jumper or a jumper across pins 1-2 indicates that the programmed ENV settings should be used during boot. A jumper across pins 2-3 indicates that the safe ENV settings should be used.

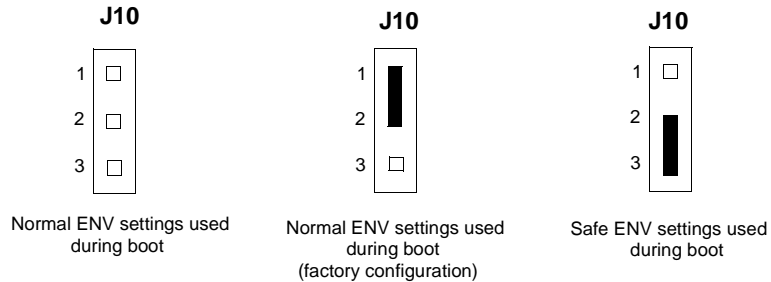

Flash 0 Block Write Protect Header (J15)

A 2-pin planar header supports the Intel K3 Flash family write protect feature. No jumper installed enables the lock-down mechanism. Blocks locked down cannot be unlocked with the unlock command. The jumper must be installed in order to override the lock-down function and enable blocks to be erased or programmed through software. Refer to the Intel K3 Flash data sheet, listed in [Appendix D, Related Documentation](#), for further details.

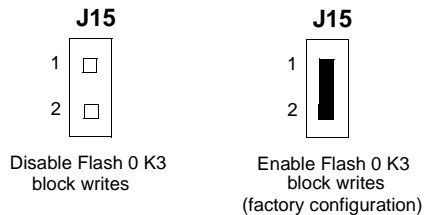

SROM Initialization Enable Header (J17)

A 3-pin planar header enables/disables the GT-64260B SROM initialization. No jumper or a jumper across pins 1-2 enables the GT-64260B device initialization via I2C SROM while a jumper across pins 2-3 disables this initialization sequence.

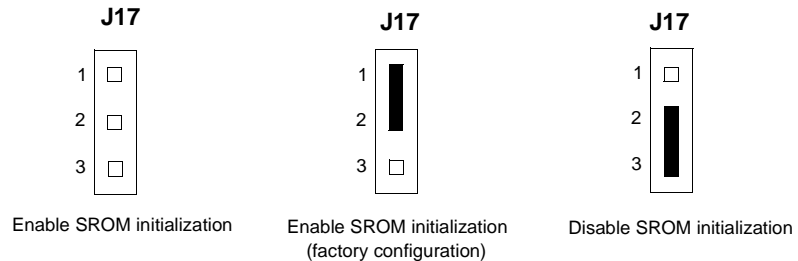

PowerPC Bus Mode Select Header (J19)

A 3-pin planar header selects the processor bus operating mode. No jumper or a jumper across pins 1-2 selects the 60x bus mode while a jumper across pins 2-3 selects the MPX bus mode.

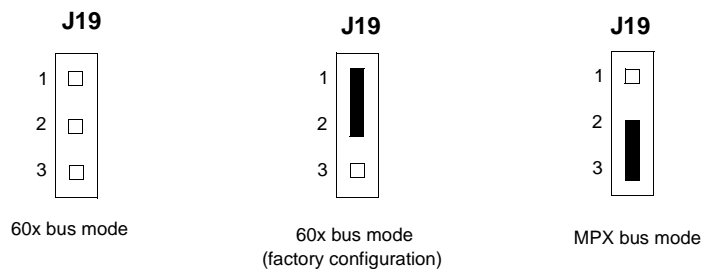

CPU COP Enable Header (J20)

A 2-pin planar header enables the Riscwatch capability. No jumper installed disables COP and enables boundary scan. A jumper across pins 1-2 enables the COP emulator debug.

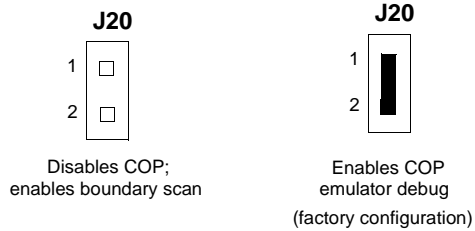

PCI Bus 0.0 Speed Header (J25)

A 2-pin planar header that can force PCI bus 0.0 to run at 33 MHz rather than the standard method of allowing the PMC board to control whether the bus runs at 33 MHz or 66 MHz. No jumper installed allows the PMC board to choose the PCI 0.0 bus speed. A jumper installed across pins 1-2 forces PCI bus 0.0 to run at 33 MHz.

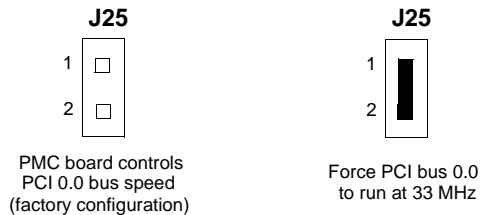

VME SCON Select Header (J27)

A 3-pin planar header allows the choice for auto/enable/disable SCON VME configuration. A jumper installed across pins 1-2 configures for SCON disabled. A jumper installed across pins 2-3 configures for auto SCON. No jumper installed configures for SCON always enabled.

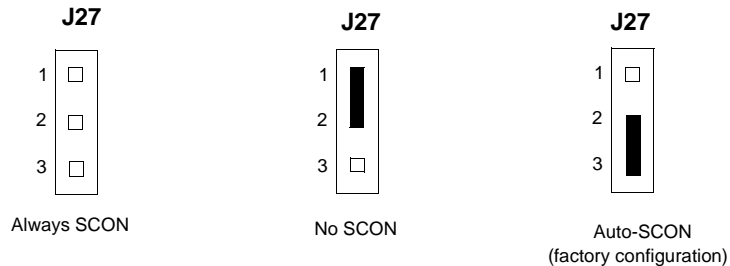

PCI Bus 1.0 Speed Header (J29)

A 2-pin planar header that can force PCI bus 1.0 to run at 33 MHz rather than the standard method of allowing the PMC board to control whether the bus runs at 33 MHz or 66 MHz. No jumper installed allows the PMC board to choose the PCI 1.0 bus speed. A jumper installed across pins 1-2 forces PCI bus 1.0 to run at 33 MHz.

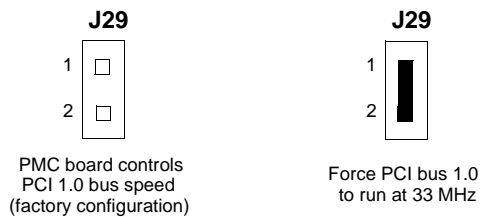

EEPROM Write Protect Header (J30)

A 2-pin planar header enables/disables programming of the on-board EEPROMs as a means of protecting the contents from being corrupted. No jumper installed disables EEPROM programming by driving the WP pin to a logic high. The jumper must be installed in order to program any of the EEPROMs at addresses A0, A6, A8, and/or AA.

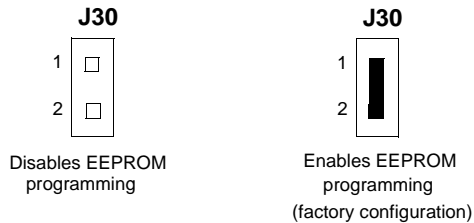

Setting the PMC Vio Keying Pin

Signalling voltage (V_{io}) is determined by the location of the PMC Vio keying pin. Each site can be independently configured for either 5V or 3.3V signalling. The option selected can be determined by observing the location of the Vio keying pin.

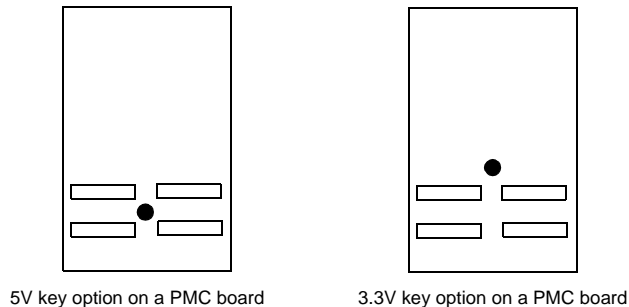

Hardware Installation

Installing the MVME5500 into a Chassis

Use the following steps to install the MVME5500 into your computer chassis.

1. Attach an ESD strap to your wrist. Attach the other end of the ESD strap to an electrical ground (refer to *Unpacking Guidelines*). The ESD strap must be secured to your wrist and to ground throughout the procedure.
2. Remove any filler panel that might fill that slot.
3. Install the top and bottom edge of the MVME5500 into the guides of the chassis.



Only use injector handles for board insertion to avoid damage/deformation to the front panel and/or PCB.

4. Ensure that the levers of the two injector/ejectors are in the outward position.
5. Slide the MVME5500 into the chassis until resistance is felt.
6. Simultaneously move the injector/ejector levers in an inward direction.
7. Verify that the MVME5500 is properly seated and secure it to the chassis using the two screws located adjacent to the injector/ejector levers.
8. Connect the appropriate cables to the MVME5500.

Connection to Peripherals

When the MVME5500 is installed in a chassis, you are ready to connect peripherals and apply power to the board.

[Figure 1-1 on page 1-7](#) shows the locations of the various connectors while [Table 1-3](#) lists them for you. Refer to [Chapter 5, Pin Assignments](#) for the pin assignments of the connectors listed below.

Note If a PMC module is plugged into PMC slot 1, the memory mezzanine card cannot be used because the PMC module covers the memory mezzanine connector.

Table 1-3. MVME5500 Connectors

Connector	Function
J1	COM1 front-panel connector
J2	Dual 1000/100/10BaseT front-panel connectors
J3	IPMC connector
J4	PCI/PMC expansion connector
J5	CPU COP connector
J11, J12, J13, J14	PMC 1 connectors
J18	Boundary scan connector
J21, J22, J23, J24	PMC 2 connectors
J33	COM2 planar connector
P1, P2	VME rear panel connectors
P4	Memory expansion connector

Completing the Installation

Verify that hardware is installed and the power/peripheral cables connected are appropriate for your system configuration.

Replace the chassis or system cover, reconnect the system to the AC or DC power source, and turn the equipment power on.

Introduction

This chapter gives you information about:

- the power-up procedure
- switches and indicators

Applying Power

After you verify that all necessary hardware preparation is complete and all connections are made correctly, you can apply power to the system.

When you are ready to apply power to the MVME5500:

- Verify that the chassis power supply voltage setting matches the voltage present in the country of use (if the power supply in your system is not auto-sensing).
- On powering up, the MVME5500 brings up the MotLoad prompt, `MVME5500>`.

Switches and Indicators

The MVME5500 board provides a single pushbutton switch that provides both Abort and Reset (ABT/RST) functions. When the switch is depressed for less than three seconds, an abort interrupt is generated to the processor. If the switch is held for more than three seconds, a board hard reset is generated.

The MVME5500 has two front-panel indicators:

- ❑ BFL, software controlled. Asserted by firmware (or other software) to indicate a configuration problem (or other failure).
- ❑ CPU, connected to a CPU bus control signal to indicate bus activity.

The following table describes these indicators:

Table 2-1. Front-Panel LED Status Indicators

Function	Label	Color	Description
CPU Bus Activity	CPU	Green	CPU bus is busy.
Board Fail	BFL	Yellow	Board has a failure.

Introduction

This chapter describes the basic features of the MOTLoad firmware product, designed by Motorola as the next generation initialization, debugger and diagnostic tool for high-performance embedded board products using state-of-the-art system memory controllers and bridge chips, such as the GT-64260B.

In addition to an overview of the product, this chapter includes a list of standard MOTLoad commands and the default VME settings that are changeable by the user, as allowed by the firmware.

Overview

The MOTLoad firmware package serves as a board power-up and initialization package, as well as a vehicle from which user applications can be booted. A secondary function of the MOTLoad firmware is to serve in some respects as a test suite providing individual tests for certain devices.

MOTLoad is controlled through an easy-to-use, UNIX-like, command line interface. The MOTLoad software package is similar to many end-user applications designed for the embedded market, such as the real time operating systems currently available.

Refer to the *MOTLoad Firmware Package User's Manual*, listed in [Appendix D, Related Documentation](#), for more details.

MOTLoad Implementation and Memory Requirements

The implementation of MOTLoad and its memory requirements are product specific. The MVME5500 single-board computer (SBC) is offered with a wide range of memory (for example, DRAM, external cache, Flash). Typically, the smallest amount of on-board DRAM that a Motorola SBC has is 32MB. Each supported Motorola product line has its own

unique MOTLoad binary image(s). Currently the largest MOTLoad compressed image is less than 1MB in size.

3

MOTLoad Commands

MOTLoad supports two types of commands (applications): utilities and tests. Both types of commands are invoked from the MOTLoad command line in a similar fashion. Beyond that, MOTLoad utilities and MOTLoad tests are distinctly different.

MOTLoad Utility Applications

The definition of a MOTLoad utility application is very broad. Simply stated, it is considered a MOTLoad command, if it is not a MOTLoad test. Typically, MOTLoad utility applications are applications that aid the user in some way (that is, they do something useful). From the perspective of MOTLoad, examples of utility applications are: configuration, data/status displays, data manipulation, help routines, data/status monitors, etc.

Operationally, MOTLoad utility applications differ from MOTLoad test applications in several ways:

- ❑ Only one utility application operates at any given time (that is, multiple utility applications can not be executing concurrently).
- ❑ Utility applications may interact with the user. Most test applications do not.

MOTLoad Tests

A MOTLoad test application determines whether or not the hardware meets a given standard. Test applications are validation tests. Validation is conformance to a specification. Most MOTLoad tests are designed to directly validate the functionality of a specific SBC subsystem or component. These tests validate the operation of such SBC modules as: dynamic memory, external cache, NVRAM, real time clock, etc.

All MOTLoad tests are designed to validate functionality with minimum user interaction. Once launched, most MOTLoad tests operate

automatically without any user interaction. There are a few tests where the functionality being validated requires user interaction (that is, switch tests, interactive plug-in hardware modules, etc.). Most MOTLoad test results (error-data/status-data) are logged, not printed. All MOTLoad tests/commands have complete and separate descriptions (refer to the *MOTLoad Firmware Package User's Manual* for this information).

All devices that are available to MOTLoad for validation/verification testing are represented by a unique device path string. Most MOTLoad tests require the operator to specify a test device at the MOTLoad command line when invoking the test.

A listing of all device path strings can be displayed through the **devShow** command. If an SBC device does not have a device path string, it is not supported by MOTLoad and can not be directly tested. There are a few exceptions to the device path string requirement, like testing RAM, which is not considered a true device and can be directly tested without a device path string. Refer to the **devShow** command description page in the *MOTLoad Firmware Package User's Manual*.

Most MOTLoad tests can be organized to execute as a group of related tests (a testSuite) through the use of the **testSuite** command. The expert operator can customize their testing by defining and creating a custom testSuite(s). The list of built-in and user-defined MOTLoad testSuites, and their test contents, can be obtained by entering **testSuite -d** at the MOTLoad prompt. All testSuites that are included as part of a product specific MOTLoad firmware package are product specific. For more information, refer to the **testSuite** command description page in the *MOTLoad Firmware Package User's Manual*.

Test results and test status are obtained through the **testStatus**, **errorDisplay**, and **taskActive** commands. Refer to the appropriate command description page in the *MOTLoad Firmware Package User's Manual* for more information.

Using MOTLoad

Interaction with MOTLoad is performed via a command line interface through a serial port on the SBC, which is connected to an X-terminal or other terminal emulator (for example, Window's Hypercomm). The default MOTLoad serial port settings are: 9600 baud, 8 bits, no parity.

Command Line Interface

The MOTLoad command line interface is similar to a UNIX command line shell interface. Commands are initiated by entering a valid MOTLoad command (a text string) at the MOTLoad command line prompt and pressing the carriage-return key to signify the end of input. MOTLoad then performs the specified action. An example of a MOTLoad command line prompt is shown below. The MOTLoad prompt changes according to what product it is used on (for example, MVME5500, MVME6100).

Example:

```
MVME5500>
```

If an invalid MOTLoad command is entered at the MOTLoad command line prompt, MOTLoad displays a message that the command was not found.

Example:

```
MVME5500> mytest  
"mytest" not found  
MVME5500>
```

If the user enters a partial MOTLoad command string that can be resolved to a unique valid MOTLoad command and presses the carriage-return key, the command will be executed as if the entire command string had been entered. This feature is a user-input shortcut that minimizes the required amount of command line input. MOTLoad is an ever changing firmware package, so user-input shortcuts may change as command additions are made.

Example:

```
MVME5500> version
Copyright: Motorola Inc.1999-2002, All Rights Reserved
MOTLoad RTOS Version 2.0
PAL Version 0.1 (Motorola MVME5500)
```

Example:

```
MVME5500> ver
Copyright: Motorola Inc. 1999-2002, All Rights Reserved
MOTLoad RTOS Version 2.0
PAL Version 0.1 (Motorola MVME5500)
```

If the partial command string cannot be resolved to a single unique command, MOTLoad will inform the user that the command was ambiguous.

Example:

```
MVME5500> te
"te" ambiguous
MVME5500>
```

Command Line Help

Each MOTLoad firmware package has an extensive, product-specific help facility that can be accessed through the **help** command. The user can enter **help** at the MOTLoad command line to display a complete listing of all available tests and utilities.

Example

```
MVME5500>help
```

For help with a specific test or utility the user can enter the following at the MOTLoad prompt:

help *<command_name>*

The **help** command also supports a limited form of pattern matching. Refer to the **help** command page.

Example

```
MVME5500>help testRam
Usage: testRam [-aPh] [-bPh] [-iPd] [-nPh] [-tPd] [-v]
Description: RAM Test [Directory]
Argument/Option Description
-a Ph: Address to Start (Default = Dynamic Allocation)
-b Ph: Block Size (Default = 16KB)
-i Pd: Iterations (Default = 1)
-n Ph: Number of Bytes (Default = 1MB)
-t Ph: Time Delay Between Blocks in OS Ticks (Default = 1)
-v O : Verbose Output
MVME5500>
```

Command Line Rules

There are a few things to remember when entering a MOTLoad command:

- ❑ Multiple commands are permitted on a single command line, provided they are separated by a single semicolon(";").
- ❑ Spaces separate the various fields on the command line (command/arguments/options).
- ❑ The argument/option identifier character is always preceded by a hyphen ("-") character
- ❑ Options are identified by a single character
- ❑ Option arguments immediately follow (no spaces) the option
- ❑ All commands, command options, device tree strings, etc., are case sensitive

Example:

```
MVME5500> flashProgram -d/dev/flash0 -n00100000
```

For more information on MOTLoad operation and function, refer to the *MOTLoad Firmware Package User's Manual*.

MOTLoad Command List

The following table provides a list of all current MOTLoad commands. Products supported by MOTLoad may or may not employ the full command set. Typing `help` at the MOTLoad command prompt will display all commands supported by MOTLoad for a given product.

Table 3-1. MOTLoad Commands

Command	Description
as	One-Line Instruction Assembler
bc b bch bcw	Block Compare Byte/Halfword/Word
bdTempShow	Display Current Board Temperature
bfb bfh bfw	Block Fill Byte/Halfword/Word
blkCp	Block Copy
blkFmt	Block Format
blkRd	Block Read
blkShow	Block Show Device Configuration Data
blkVe	Block Verify
blkWr	Block Write
bmb bmh bmw	Block Move Byte/Halfword/Word
br	Assign/Delete/Display User-Program Break-Points
bsb bsh bsw	Block Search Byte/Halfword/Word
bvb bv h bv w	Block Verify Byte/Halfword/Word
cdDir	ISO9660 File System Directory Listing
cdGet	ISO9660 File System File Load
clear	Clear the Specified Status/History Table(s)
cm	Turns on Concurrent Mode
devShow	Display (Show) Device/Node Table
diskBoot	Disk Boot (Direct-Access Mass-Storage Device)

Table 3-1. MOTLoad Commands (continued)

Command	Description
downLoad	Down Load S-Record from Host
ds	One-Line Instruction Disassembler
echo	Echo a Line of Text
elfLoader	ELF Object File Loader
errorDisplay	Display the Contents of the Test Error Status Table
eval	Evaluate Expression
execProgram	Execute Program
fatDir	FAT File System Directory Listing
fatGet	FAT File System File Load
fdShow	Display (Show) File Descriptor
flashProgram	Flash Memory Program
flashShow	Display Flash Memory Device Configuration Data
gd	Go Execute User-Program Direct (Ignore Break-Points)
gevDelete	Global Environment Variable Delete
gevDump	Global Environment Variable(s) Dump (NVRAM Header + Data)
gevEdit	Global Environment Variable Edit
gevInit	Global Environment Variable Area Initialize (NVRAM Header)
gevList	Global Environment Variable Labels (Names) Listing
gevShow	Global Environment Variable Show
gn	Go Execute User-Program to Next Instruction
go	Go Execute User-Program
gt	Go Execute User-Program to Temporary Break-Point
hbd	Display History Buffer
hbx	Execute History Buffer Entry
help	Display Command/Test Help Strings

Table 3-1. MOTLoad Commands (continued)

Command	Description
l2CacheShow	Display state of L2 Cache and L2CR register contents
l3CacheShow	Display state of L3 Cache and L3CR register contents
mdb mdh mdw	Memory Display Bytes/Halfwords/Words
memShow	Display Memory Allocation
mmb mmh mmw	Memory Modify Bytes/Halfwords/Words
mpuFork	Execute program from idle processor
mpuShow	Display multi-processor control structure
mpuSwitch	Resets board switching master MPU
netBoot	Network Boot (BOOT/TFTP)
netShow	Display Network Interface Configuration Data
netShut	Disable (Shutdown) Network Interface
netStats	Display Network Interface Statistics Data
noCm	Turns off Concurrent Mode
pciDataRd	Read PCI Device Configuration Header Register
pciDataWr	Write PCI Device Configuration Header Register
pciDump	Dump PCI Device Configuration Header Register
pciShow	Display PCI Device Configuration Header Register
pciSpace	Display PCI Device Address Space Allocation
ping	Ping Network Host
portSet	Port Set
portShow	Display Port Device Configuration Data
rd	User Program Register Display
reset	Reset System
rs	User Program Register Set
set	Set Date and Time

Table 3-1. MOTLoad Commands (continued)

Command	Description
sromRead	SROM Read
sromWrite	SROM Write
sta	Symbol Table Attach
stl	Symbol Table Lookup
stop	Stop Date and Time (Power-Save Mode)
taskActive	Display the Contents of the Active Task Table
tc	Trace (Single-Step) User Program
td	Trace (Single-Step) User Program to Address
testDisk	Test Disk
testEnetPtP	Ethernet Point-to-Point
testFlash	Flash Memory Erase/Write/Verify
testI2cRomRd	I2C ROM Read
testNvramRd	NVRAM Read
testNvramRdWr	NVRAM Read/Write (Destructive)
testRam	RAM Test (Directory)
testRamAddr	RAM Addressing
testRamAlt	RAM Alternating
testRamBitToggle	RAM Bit Toggle
testRamBounce	RAM Bounce
testRamCodeCopy	RAM Code Copy and Execute
testRamEccMonitor	Monitor for ECC Errors
testRamMarch	RAM March
testRamPatterns	RAM Patterns
testRamPerm	RAM Permutations
testRamQuick	RAM Quick

Table 3-1. MOTLoad Commands (continued)

Command	Description
testRamRandom	RAM Random Data Patterns
testRtcAlarm	RTC Alarm
testRtcReset	RTC Reset
testRtcRollOver	RTC Rollover
testRtcTick	RTC Tick
testSerialExtLoop	Serial External Loopback
testSerialIntLoop	Serial Internal Loopback
testStatus	Display the Contents of the Test Status Table
testSuite	Execute Test Suite
testSuiteMake	Make (Create) Test Suite
testUsbOscillator	USB Oscillator
testUsbVok	USB Vok
testWatchdogTimer	Tests the accuracy of the watchdog timer device.
tftpGet	TFTP Get
tftpPut	TFTP Put
time	Display Date and Time
transparentMode	Transparent Mode (Connect to Host)
tsShow	Display Task Status
upLoad	Up Load Binary-Data from Target
version	Display Version String(s)
vmeCfg	Manages user specified VME configuration parameters
vpdDisplay	VPD Display
vpdEdit	VPD Edit
waitProbe	Wait for I/O Probe to Complete

VME Settings

As shipped from the factory, the firmware on the MVME5500 will program default values into the Universe II VME Interface chip. The firmware allows certain VME settings to be changed in order for the user to customize his/her environment. The following is a description of the default VME settings that are changeable by the user. For more information, refer to the *MOTLoad User's Manual* and Tundra's *Universe II User Manual*, listed in [Appendix D, Related Documentation](#).

- VME3PCI Master Enable = Y
N = Do not set up or enable the VMEbus Interface.
Y= Set up and enable the VMEbus Interface.
- PCI Slave Image 0
This image is set to zeroes and thus disabled.
- PCI Slave Image 1 Control = C0820000
Sets LSII_CTL to indicate that this image is enabled, write posting is enabled, VMEbus data width is 32 bits, VMEbus address space is A32, data and non-supervisory AM encoding, no BLT transfers to the VMEbus, and to accept addresses in PCI memory space.
- PCI Slave Image 1 Base Address Register = 91000000
Sets LSII_BS to indicate that the lower bound of PCI memory addresses to be transferred to the VMEbus by this image is 0x91000000.
- PCI Slave Image 1 Bound Address Register = B0000000
Sets LSII_BD to indicate that the upper bound of PCI memory addresses to be transferred by this image is 0xB0000000.
- PCI Slave Image 1 Translation Offset = 70000000
Sets LSII_TO to indicate that the PCI memory address is to be translated by 0x70000000 before presentation on the VMEbus; the result of the translation is: $0x91000000 + 0x70000000 = 0x010100000$, thus 0x01000000 on the VMEbus.

- ❑ `PCI Slave Image 2 Control = C0410000`

Sets `LSI2_CTL` to indicate that this image is enabled, write posting is enabled, VMEbus data width is 16 bits, VMEbus address space is A24, data and non-supervisory AM encoding, no BLT transfers to the VMEbus, and to accept addresses in PCI memory space.
- ❑ `PCI Slave Image 2 Base Address Register = B0000000`

Sets `LSI2_BS` to indicate that the lower bound of PCI memory addresses to be transferred to the VMEbus by this image is `0xB0000000`.
- ❑ `PCI Slave Image 2 Bound Address Register = B1000000`

Sets `LSI2_BD` to indicate that the upper bound of PCI memory addresses to be transferred by this image is `0xB1000000`.
- ❑ `PCI Slave Image 2 Translation Offset = 400000000`

Sets `LSI2_TO` to indicate that the PCI memory address is to be translated by `0x40000000` before presentation on the VMEbus; the result of the translation is: $0xB0000000 + 0x40000000 = 0xF0000000$, thus `0xF0000000` on the VMEbus.
- ❑ `PCI Slave Image 3 Control = C0400000`

Sets `LSI3_CTL` to indicate that this image is enabled, write posting is enabled, VMEbus data width is 16 bits, VMEbus address space is A16, data and non-supervisory AM encoding, no BLT transfers to the VMEbus, and to accept addresses in PCI memory space.
- ❑ `PCI Slave Image 3 Base Address Register = B3FF0000`

Sets `LSI3_BS` to indicate that the lower bound of PCI memory addresses to be transferred to the VMEbus by this image is `0xB3FF0000`.
- ❑ `PCI Slave Image 3 Bound Address Register = B4000000`

Sets `LSI3_BD` to indicate that the upper bound of PCI memory addresses to be transferred by this image is `0xB4000000`.

- ❑ `PCI Slave Image 3 Translation Offset = 4C000000`

Sets `LSI3_TO` to indicate that the PCI memory address is to be translated by `0x4C000000` before presentation on the VMEbus; the result of the translation is: `0xB3FF0000 + 0x4C000000 = 0xFFFF0000`, thus `0xFFFF0000` on the VMEbus.
- ❑ `PCI Slave Image 4 -7`

These images are set to zeroes and thus disabled.
- ❑ `VMEbus Slave Image 0 Control = E0F20000`

Sets `VSIO_CTL` to indicate that this image is enabled, write and read posting is enabled, program/data and supervisory AM coding, data width is 32 bits, VMEbus A32 address space, 64-bit PCI transfers are disabled, PCI Lock on RMW cycles are disabled, and to transfer into PCI memory space.
- ❑ `VMEbus Slave Image 0 Base Address Register = 00000000`

Sets `VSIO_BS` to define the lower bound of VME addresses to be transferred to the local PCI bus is `0x00000000`.
- ❑ `VMEbus Slave Image 0 Bound Address Register = (Local DRAM Size)`

Sets `VSIO_BD` to define that the upper bound of VME addresses to be equal to the size of local DRAM.
- ❑ `VMEbus Slave Image 0 Translation Offset = 00000000`

Sets `VSIO_TO` to define that no translation of the VMEbus address is to occur when transferred to the local PCI bus. According to the `CHRP` map in use by MOTLoad, this will result in transfers to local DRAM; that is, `0x00000000` on the VMEbus is `0x00000000` in local DRAM.
- ❑ `VMEbus Slave Image 1 - 7`

These images are set to zeroes and thus disabled.
- ❑ `VMEbus Register Access Image Control Register = 00000000`

The `VRAI_CTL` register is disabled.

- ❑ VMEbus Register Access Image Base Address Register = 00000000
The contents of the VRAI_BS register are not applicable since the image is disabled.
- ❑ PCI Miscellaneous Register = 10000000
The LMISC register is set for Universe I compatibility and the coupled window timer is disabled.
- ❑ Special PCI Slave Image Register = 00000000
The SLSI register is disabled.
- ❑ Master Control Register = 00C00000
The MAST_CTL register is set to retry forever before the PCI master signals error, transfer 128 bytes on posted writes before release, use VMEbus request level 3, request mode = Demand, Release When Done, align PCI transfers on 32 bytes, and use PCI bus 0.
- ❑ Miscellaneous Control Register = 52040000
Sets MISC_CTL register to utilize 256 second VMEbus timeout, round robin arbitration, 256 second arbitration timeout, do not use BI-mode and assertion of VIRQ1 is to be ignored.
- ❑ User AM Codes = 40400000
Sets USER_AM to indicate a user AM code of 0.

The resulting map is therefore:

PCI addresses 0x91000000 - 0xB0000000: VMEbus A32/D32 space, addresses 0x01000000 - 0x20000000.

PCI addresses 0xB0000000 - 0xB1000000: VMEbus A24/D16 space, addresses 0xF0000000 - 0xF1000000.

PCI addresses 0xB3FF0000 - 0xB4000000: VMEbus A16/D16 space, addresses 0xFFFF0000 - 0xFFFFFFFF.

VMEbus A32/D32 addresses from 0x00000000 to (local DRAM size) address the local memory of the MVME5500.

The following sections provide additional information pertaining to the VME firmware settings of the MVME5500. A few VME settings are controlled by hardware jumpers while the majority of the VME settings are managed by the firmware command utility **vmeCfg**.

CR/CSR Settings

The firmware supports both Auto Slot ID and Geographical Addressing for assigning the CR/CSR base address dependent on a hardware jumper setting. See the VME64 Specification and the VME64 Extensions for details. As a result, a 512K byte CR/CSR area can be accessed from the VMEbus using the CR/CSR AM code.

Displaying VME Settings

To display the changeable VME setting, type the following at the firmware prompt:

- vmeCfg -s -m**
Displays Master Enable state
- vmeCfg -s -i(0 - 7)**
Displays selected Inbound Window state
- vmeCfg -s -o(0 - 7)**
Displays selected Outbound Window state
- vmeCfg -s -r184**
Displays PCI Miscellaneous Register state
- vmeCfg -s -r188**
Displays Special PCI Target Image Register state
- vmeCfg -s -r400**
Displays Master Control Register state
- vmeCfg -s -r404**
Displays Miscellaneous Control Register state

- vmeCfg -s -r40C**
Displays User AM Codes Register state
- vmeCfg -s -rF70**
Displays VMEbus Register Access Image Control Register state

Editing VME Settings

To edit the changeable VME setting, type the following at the firmware prompt:

- vmeCfg -e -m**
Edits Master Enable state
- vmeCfg -e -i(0 - 7)**
Edits selected Inbound Window state
- vmeCfg -e -o(0 - 7)**
Edits selected Outbound Window state
- vmeCfg -e -r184**
Edits PCI Miscellaneous Register state
- vmeCfg -e -r188**
Edits Special PCI Target Image Register state
- vmeCfg -e -r400**
Edits Master Control Register state
- vmeCfg -e -r404**
Edits Miscellaneous Control Register state
- vmeCfg -e -r40C**
Edits User AM Codes Register state
- vmeCfg -e -rF70**
Edits VMEbus Register Access Image Control Register state

Deleting VME Settings

To delete the changeable VME setting (restore default value), type the following at the firmware prompt:

- vmeCfg -d -m**
Deletes Master Enable state
- vmeCfg -d -i(0 - 7)**
Deletes selected Inbound Window state
- vmeCfg -d -o(0 - 7)**
Deletes selected Outbound Window state
- vmeCfg -d -r184**
Deletes PCI Miscellaneous Register state
- vmeCfg -d -r188**
Deletes Special PCI Target Image Register state
- vmeCfg -d -r400**
Deletes Master Control Register state
- vmeCfg -d -r404**
Deletes Miscellaneous Control Register state
- vmeCfg -d -r40C**
Deletes User AM Codes Register state
- vmeCfg -d -rF70**
Deletes VMEbus Register Access Image Control Register state

Restoring Default VME Settings

To restore all of the changeable VME setting back to their default settings, type the following at the firmware prompt:

vmeCfg -z

Remote Start

As described in the *MOTLoad Firmware Package User's Manual*, listed in [Appendix D, Related Documentation](#), remote start allows the user to obtain information about the target board, download code and/or data, modify memory on the target, and execute a downloaded program. These transactions occur across the VMEbus in the case of the MVME5500. MOTLoad uses one of four mailboxes in the Universe II as the inter-board communication address (IBCA) between the host and the target.

CR/CSR slave addresses configured by MOTLoad are assigned according to the installation slot in the backplane, as indicated by the *VME64 Specification*. For reference, the following values are provided:

CR/CSR space for a board in the 1st slot will start at 0x0008.0000
CR/CSR space for a board in the 2nd slot will start at 0x0010.0000
CR/CSR space for a board in the 3rd slot will start at 0x0018.0000
CR/CSR space for a board in the 4th slot will start at 0x0020.0000
CR/CSR space for a board in the 5th slot will start at 0x0028.0000
CR/CSR space for a board in the 6th slot will start at 0x0030.0000
CR/CSR space for a board in the 7th slot will start at 0x0038.0000
CR/CSR space for a board in the 8th slot will start at 0x0040.0000
CR/CSR space for a board in the 9th slot will start at 0x0048.0000
CR/CSR space for a board in the ath slot will start at 0x0050.0000
CR/CSR space for a board in the bth slot will start at 0x0058.0000
CR/CSR space for a board in the cth slot will start at 0x0060.0000

For further details on CR/CSR space, please refer to the *VME64 Specification*, listed in [Appendix D, Related Documentation](#).

The MVME5500 uses a Tundra Universe II for its VME bridge. The offsets of the mailboxes in the Universe II are defined in the *Universe II User Manual*, listed in [Appendix D, Related Documentation](#), but are noted here for reference:

Mailbox 0 is at offset 7f348 in the CR/CSR space
Mailbox 1 is at offset 7f34C in the CR/CSR space
Mailbox 2 is at offset 7f350 in the CR/CSR space
Mailbox 3 is at offset 7f354 in the CR/CSR space

The selection of the mailbox used by remote start on an individual MVME5500 is determined by the setting of a global environment variable (GEV). The default mailbox is zero. Another GEV controls whether remote start is enabled (default) or disabled. Refer to the *Remote Start* chapter in the *MOTLoad Firmware Package User's Manual* for remote start GEV definitions.

The MVME5500's IBCA needs to be mapped appropriately through the master's VMEbus bridge. For example, to use remote start using mailbox 0 on an MVME5500 installed in slot 5, the master would need a mapping to support reads and writes of address 0x002ff348 in VME CR/CSR space (0x280000 + 0x7f348).

This chapter describes the MVME5500 on a block diagram level.

Features

The following table lists the features of the MVME5500.

Table 4-1. MVME5500 Features Summary

Feature	Description
Processor	<ul style="list-style-type: none">– Single 1 GHz MPC7455 processor– Bus clock frequency at 133 MHz
L3 Cache	<ul style="list-style-type: none">– 2MB using DDR SRAM– Bus clock frequency at 200 MHz
Flash	<ul style="list-style-type: none">– 8MB Flash soldered on board– 32MB expansion Flash soldered on board
System Memory	<ul style="list-style-type: none">– Two banks on board for 512MB using 256Mb devices– Expansion connector for a mezzanine board with two banks for 512MB using 256Mb devices– Double-bit-error detect, single-bit-error correct across 72 bits– Bus clock frequency at 133 MHz
Memory Controller	<ul style="list-style-type: none">– Provided by GT-64260B– Supports one to four banks of SDRAM for up to 1GB per bank
Processor Host Bridge	<ul style="list-style-type: none">– Provided by GT-64260B– Supports MPX mode or 60x mode
PCI Interfaces	<ul style="list-style-type: none">– Provided by GT-64260B– Two independent 64-bit interfaces, one compliant to PCI spec rev 2.1 (Bus 0.0) and the other compliant to PCI spec rev 2.2 (Bus 1.0)– Bus clock frequency at 66 MHz
	<ul style="list-style-type: none">– Provided by the HiNT PCI 6154 secondary interface– One 64-bit interface, compliant to PCI spec rev 2.1 (Bus 0.1)– Bus clock frequency at 33 MHz

Table 4-1. MVME5500 Features Summary (continued)

Feature	Description
Interrupt Controller	<ul style="list-style-type: none"> – Provided by GT-64260B – Interrupt sources internal to GT-64260B – Up to 32 external interrupt inputs – Up to seven interrupt outputs
Counters/Timers	– Eight 32-bit counters/timers in GT-64260B
I2C	<ul style="list-style-type: none"> – Provided by GT-64260B – Master or slave capable – On-board serial EEPROMs for VPD, SPD, GT-64260B init, and user data storage
NVRAM	– 32KB provided by MK48T37
Real Time Clock	– Provided by MK48T37
Watchdog Timers	<ul style="list-style-type: none"> – One in GT-64260B – One in MK48T37 – Each watchdog timer can generate interrupt or reset, software selectable
On-board Peripheral Support	<ul style="list-style-type: none"> – One 10/100/1000BaseT Ethernet interface, one 10/100BaseT Ethernet interface – Dual 16C550 compatible UARTs
PCI Mezzanine Cards	– Two PMC sites (one shared with the expansion memory and has IPMC capability)
PCI Expansion	– One expansion connector for interface to PMCspan
Miscellaneous	<ul style="list-style-type: none"> – Reset/Abort switch – Front-panel status indicators, Run and Board Fail
Form Factor	– Standard VME

Block Diagram

[Table 4-1](#) shows a block diagram of the overall board architecture.

MVME5500 provides 1.5V as the SRAM I/O voltage. The L3 bus operates at 200 MHz.

System Controller

4

The GT-64260B system controller for PowerPC architecture processors is a single chip solution that provides the following features:

- ❑ A 64-bit interface to the CPU bus
- ❑ A 64-bit SDRAM interface
- ❑ A 32-bit generic device interface for Flash, etc.
- ❑ Two 64-bit, 66 MHz PCI bus interfaces
- ❑ Three 10/100Mb Ethernet MAC ports (two ports not used)
- ❑ A DMA engine for moving data between the buses
- ❑ An interrupt controller
- ❑ An I2C device controller
- ❑ PowerPC bus arbiter
- ❑ Counter/timers
- ❑ Watchdog timer

Each of the device buses are de-coupled from each other, enabling concurrent operation of the CPU bus, PCI buses, and access to SDRAM. Refer to the *GT-64260B System Controller for PowerPC Processors Data Sheet*, listed in [Appendix D, Related Documentation](#), for more details.

CPU Bus Interface

The GT-64260B supports MPX or 60x bus mode operation. The MVME5500 board has jumper/build option resistors to select either operating mode at power-up.

Memory Controller Interface

The GT-64260B can access up to four banks of SDRAM for a total of 1GB of SDRAM memory. The memory bus is capable of operating up to 133 MHz.

The MVME5500 board has two banks on board and a connector for an expansion mezzanine board with two additional banks.

Interrupt Controller

The MVME5500 uses the interrupt controller integrated into GT-64260B to manage the GT-64260B internal interrupts, as well as the external interrupt requests. The external interrupt sources include the following:

- On-board PMC interrupts
- LAN interrupts
- VME interrupts
- RTC interrupt
- Watchdog timer interrupts
- Abort switch interrupt
- External UART interrupts

The interrupt controller provides up to seven interrupt output pins for various interrupt functions. For additional details regarding the external interrupt assignments, refer to the *MVME5500 Single-Board Computer Programmer's Reference Guide*.

I2C Serial Interface and Devices

A two-wire serial interface for the MVME5500 board is provided by a master/slave capable I2C serial controller integrated into the GT-64260B device. The I2C serial controller provides two basic functions. The first function is to optionally provide GT-64260B register initialization following a reset. The GT-64260B can be configured (by setting jumper J17) to automatically read data out of a serial EEPROM following a reset

and initialize any number of internal registers. In the second function, the controller is used by the system software to read the contents of the VPD EEPROM contained on the MVME5500 board, along with the SPD EEPROM(s), to further initialize the memory controller and other interfaces.

The MVME5500 board contains the following I2C serial devices:

- ❑ 256 byte EEPROM for fixed GT-64260B initialization
- ❑ 8KB EEPROM for VPD
- ❑ 8KB EEPROM for user-defined VPD
- ❑ 256 byte EEPROM for SPD
- ❑ DS1621 temperature sensor

The 8KB EEPROM devices are implemented using Atmel AT24C64 devices. These devices use two byte addressing to address the 8KB of the device.

Direct Memory Access (DMA)

The GT-64260B has an 8-channel DMA controller integrated in the device. Each DMA channel is capable of moving data between any source and any destination. This controller can be programmed to move up to 16MB of data per transaction. The GT-64260B DMA channels also support chained mode of operation. For additional details regarding the GT-64260B DMA capability, refer to the *GT-64260B System Controller for PowerPC Processors Data Sheet*, listed in [Appendix D, Related Documentation](#).

Timers

The GT-64260B supplies eight 32-bit counters/timers, each of which can be programmed to operate as a counter or a timer. The timing reference is based on the GT-64260B Tclk input, which is set at 133 MHz. Each counter/timer is capable of generating an interrupt.

The GT-64260B also has an internal 32-bit watchdog timer that can be configured to generate an NMI or a board reset. After the watchdog timer is enabled, it becomes a free running counter that must be serviced

periodically to keep it from expiring. Following reset, the watchdog timer is disabled.

The watchdog timer has two output pins, WDNMI and WDE. The WDNMI is asserted after the timer is enabled and the 24-bit NMI_VAL count is reached. The WDNMI pin is connected to one of the GT-64260B interrupt input pins so that an interrupt is generated when the NMI_VAL count is reached. The WDE pin is asserted after the watchdog timer is enabled and the 32-bit watchdog count expires. The WDE pin is connected to the board reset logic so that a board reset is generated when WDE is asserted. For additional details, refer to the *GT-64260B System Controller for PowerPC Processors Data Sheet*, listed in [Appendix D, Related Documentation](#).

Flash Memory

The MVME5500 contains two banks of Flash memory accessed via the device controller contained within the GT-64260B. The standard MVME5500 product is built with the 128Mb devices.

System Memory

System memory for the MVME5500 is provided by one to four banks of ECC synchronous DRAM in two banks. During system initialization, the firmware determines the presence and configuration of each memory bank installed by reading the contents of the serial presence detection (SPD) EEPROM on the board, and another one on the expansion memory module. The system firmware then initializes the GT-64260B memory controller for proper operation based on the contents of the serial presence detection EEPROM.

Note If a PMC module is plugged into PMC slot 1, the memory mezzanine card cannot be used because the PMC module covers the memory mezzanine connector.

PCI Local Buses and Devices

The GT-64260B on the MVME5500 provides two independent 64-bit, 33/66 MHz PCI buses. The GT-64260B documentation refers to these buses as PCI Bus 0 and PCI Bus 1.

The devices on Bus 1 are the GT-64260B PCI bridge 1, one 32/64-bit PMC slot, and an 825544EI LAN device. The devices on Bus 0 are the GT-64260B PCI bridge 0, one 32/64-bit PMC slot, and a HiNT PCI 6154 PCI-to-PCI bridge. For the purpose of this document, Bus 1 is also identified as PCI Bus 1.0, and Bus 0 is also identified as PCI Bus 0.0.

Gigabit Ethernet Interface

The MVME5500 provides a Gigabit Ethernet transceiver interface (1000BaseT) using an Intel 82544EI integrated Ethernet device (Ethernet 1). It also supports 100BaseTX and 10BaseT modes of operation. The Ethernet interface is accessed via an industry-standard, front-panel mounted RJ-45 connector.

10/100Mb Ethernet Interface

The 10/100Mb Ethernet interface (Ethernet 2) comes from the GT-64260B, and connects to an external PHY. This port can be routed to a front-panel RJ-45 connector or to the P2 connector with user-configurable jumpers.

Each Ethernet interface is assigned an Ethernet Station Address. The address is unique for each device. The Ethernet Station Address is displayed on a label affixed to the board. The assembly policy is to assign MAC addresses in such a manner that the higher value MAC address is assigned to Ethernet port 1 and the lower to Ethernet port 2.

In addition, the Gigabit Ethernet address is stored in a configuration ROM interfaced to the 82544EI device, while the 10/100Mb Ethernet address is stored in the on-board VPD serial EEPROM.

PCI-to-PCI Bridges

The MVME5500 uses a PCI 2.1 compliant, 66 MHz capable, HiNT PCI 6154 PCI-to-PCI bridge. The primary side connects to PCI Bus 0.0 of the GT-64260B and PMC/IPMC slot 1. The secondary side connects to PCI Bus 0.1 on which a PMC expansion connector and the VME controller resides.

PMC Sites

The MVME5500 board supports two PMC sites. Both sites support processor PMC boards with two IDSELs and two arbitration request/grant pairs. Slot 1 is connected to PCI Bus 0.0 of the GT-64260B and is 66 MHz capable. Slot 2 is connected to PCI Bus 1.0 of the GT-64260B and is also 66 MHz capable.

Note If a PMC module is plugged into PMC slot 1, the memory mezzanine card cannot be used because the PMC module covers the memory mezzanine connector.

PCI IDSEL Definition

PCI device configuration registers are accessed by using the IDSEL signal of each PCI agent to an A/D signal as defined in the *Peripheral Component Interconnect (PCI) Local Bus Specification, Revision 2.2*. IDSEL definitions for the MVME5500 are shown in the *MVME5500 Single-Board Computer Programmer's Reference Guide*.

PCI Bus Arbitration

PCI arbitration for the MVME5500 PCI Buses 0.0 and 1.0 is provided by an external arbiter PLD. The arbiter PLD implements a round-robin priority algorithm. PCI arbitration for PCI Bus 0.1 is provided by the HiNT PCI 6154 secondary internal arbiter.

Asynchronous Serial Ports

The MVME5500 board uses two TL16C550C universal asynchronous receiver/transmitters (UARTs) interfaced to the GT-64260B device bus to provide the asynchronous serial interfaces. EIA232 drivers and receivers reside on board. COM1 signals are wired to an RS-232 transceiver that interfaces to the front-panel RJ-45 connector. COM2 signals are also wired to a transceiver that interfaces to an on-board 9-pin header (refer to [Chapter 5, Pin Assignments](#), for more details). An on-board 1.8432 MHz oscillator provides the baud rate clock for the UARTs.

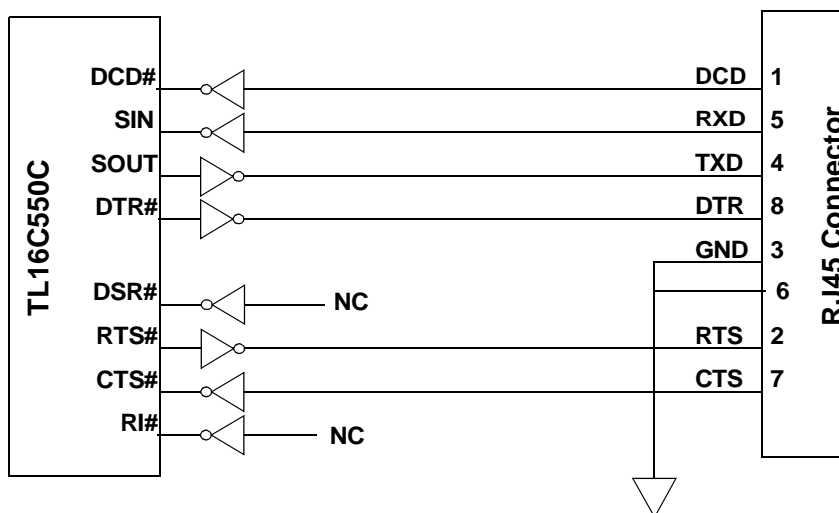

Figure 4-2. COM1 Asynchronous Serial Port Connections (RJ-45)

Real Time Clock and NVRAM

The SGS-Thomson M48T37V is used by the MVME5500 board to provide 32KB of non-volatile static RAM, real-time clock, and watchdog timer. The watchdog timer, if enabled, can be programmed to generate either an interrupt or system reset if it expires. Refer to the *MK48T37V Data Sheet* for programming information.

The M48T37V consists of two parts:

- ❑ A 44-pin 330mil SOIC device that contains the RTC, the oscillator, 32KB of SRAM, and gold-plated sockets for the SNAPHAT battery.
- ❑ A SNAPHAT battery that houses the crystal and the battery.

The SNAPHAT battery package is mounted on top of the SOIC MT48T37V device after the completion of the surface mount process. The battery housing is keyed to prevent reverse insertion.

System Control and Status Registers

The MVME5500 CPU board contains System Control and Status Registers mapped into Bank 1 of the GT-64260B device bus interface. Refer for the *MMVE5500 Single-Board Computer Programmer's Reference Guide* for details.

Sources of Reset

The sources of reset on the MVME5500 are the following:

- ❑ Power-up
- ❑ Abort/Reset Switch
- ❑ NVRAM Watchdog Timer
- ❑ GT-64260B Watchdog Timer
- ❑ System Control register bit
- ❑ VME Bus Reset

VME Interface

The MVME5500 provides a Universe II controller for the VMEbus interface.

PMC Expansion

The MVME5500 provides a PMC expansion connector to add more PMC interfaces than the two on the MVME5500 board. The connector is a Mictor AMP 767096-3 connector.

4

Debug Support

The MVME5500 provides a boundary scan header (J18) and a COP (Riscwatch) header for debug capability.

Introduction

This chapter provides pin assignments for various headers and connectors on the MMVE5500 single-board computer.

- ❑ *Asynchronous Serial Port Connector (J1)* on page 5-2
- ❑ *Ethernet Connectors (J2)* on page 5-3
- ❑ *IPMC Connector (J3)* on page 5-3
- ❑ *PCI/PMC Expansion Connector (J4)* on page 5-5
- ❑ *CPU COP Connector (J5)* on page 5-8
- ❑ *PMC 1 Interface Connectors (J11, J12, J13, J14)* on page 5-8
- ❑ *Boundary Scan Connector (J18)* on page 5-15
- ❑ *PMC 2 Interface Connectors (J21, J22, J23, J24)* on page 5-16
- ❑ *Asynchronous Serial Port (COM2) Planar Connector (J33)* on page 5-22
- ❑ *VMEbus Connectors (P1 & P2) (PMC Mode)* on page 5-22
- ❑ *VMEbus Connectors (P1 & P2) (SBC Mode)* on page 5-25
- ❑ *Memory Expansion Connector (P4)* on page 5-29

The following headers are described in this chapter:

- ❑ *Ethernet 2, PMC/SBC Mode, and P2 I/O Selection Headers (J6, J7, J28, J32, J34, J97 – J110)* on page 5-33
- ❑ *Flash Boot Bank Select Header (J8)* on page 5-40
- ❑ *Flash 0 Programming Enable Header (J9)* on page 5-40
- ❑ *Safe Start ENV Header (J10)* on page 5-41
- ❑ *Flash 0 Block Write Protect Header (J15)* on page 5-41
- ❑ *SRAM Initialization Enable Header (J17)* on page 5-42

- ❑ *Bus Mode Select Header (J19)* on page 5-42
- ❑ *COP Enable Header (J20)* on page 5-43
- ❑ *PCI Bus 0.0 Speed Header (J25)* on page 5-43
- ❑ *VME SCON Select Header (J27)* on page 5-44
- ❑ *PCI Bus 1.0 Speed Header (J29)* on page 5-44
- ❑ *EEPROM Write Protect Header (J30)* on page 5-45

Connectors

Asynchronous Serial Port Connector (J1)

An RJ-45 receptacle is located on the front panel of the MVME5500 board to provide the interface to the COM1 serial port. The pin assignments for this connector are as follows:

Table 5-1. COM1 Connector (J1) Pin Assignments

Pin	Signal
1	DCD
2	RTS
3	GNDC
4	TXD
5	RXD
6	GNDC
7	CTS
8	DTR

Ethernet Connectors (J2)

Dual RJ-45 connectors are located on the front panel of the MVME5500 to provide the interface to the 10/100/1000BaseTX Ethernet ports. The pin assignments for these connectors are as follows:

Table 5-2. Ethernet Connector (J2) Pin Assignments

Pin	1000BaseTX	10/100BaseT
1	MDIO0_P	TD+
2	MDIO0_N	TD-
3	MDIO1_P	RD+
4	MDIO2_P	AC Terminated
5	MDIO2_N	AC Terminated
6	MDIO1_N	RD-
7	MDIO3_P	AC Terminated
8	MDIO3_N	AC Terminated

5

IPMC Connector (J3)

One 40-pin Molex .635 mm (.025") pitch board-to-board receptacle (52885) is used to provide a planar interface to IPMC module signals. This receptacle mates with the Molex 53627 plug thus providing the 10.0 mm stacking height of the PMC card. The pin assignments for this connector are as follows:

Table 5-3. IPMC Connector (J3) Pin Assignments

Pin	Signal	Signal	Pin
1	I2CSCL	I2CSDA	2
3	GND	GND	4
5	DB8#	GND	6
7	GND	DB9#	8

Table 5-3. IPMC Connector (J3) Pin Assignments

Pin	Signal	Signal	Pin
9	DB10#	+3.3V	10
11	+3.3V	DB11#	12
13	DB12#	GND	14
15	GND	DB13#	16
17	DB14#	+3.3V	18
19	+3.3V	DB15#	20
21	DBP1#	GND	22
23	GND	No Connect	24
25	IPMC_INT	+3.3V	26
27	+3.3V	REQ#	28
29	GNT#	GND	30
31	GND	+3.3V	32
33	+5.0V	+5.0V	34
35	GND	GND	36
37	+5.0V	+5.0V	38
39	GND	GND	40

PCI/PMC Expansion Connector (J4)

One 114-pin Mictor connector with a center row of power and ground pins is used to provide PCI/PMC expansion capability. The pin assignments for this connector are as follows:

Table 5-4. PCI/PMC Expansion Connector (J4) Pin Assignments

Pin	Signal		Signal	Pin
1	+3.3V	GND	+3.3V	2
3	PCICLK		PMCINTA#	4
5	GND		PMCINTB#	6
7	PURST#		PMCINTC#	8
9	HRESET#		PMCINTD#	10
11	TDO		TDI	12
13	TMS		TCK	14
15	TRST#		PCIXP#	16
17	PCIXGNT#		PCIXREQ#	18
19	+12V		-12V	20
21	PERR#		SERR#	22
23	LOCK#		SDONE	24
25	DEVSEL#		SBO#	26
27	GND		GND	28
29	TRDY#		IRDY#	30
31	STOP#		FRAME#	32
33	GND		GND	34
35	ACK64#		Reserved	36
37	REQ64#		Reserved	38

Table 5-4. PCI/PMC Expansion Connector (J4) Pin Assignments (continued)

Pin	Signal		Signal	Pin
39	PAR	+5V	PCIRST#	40
41	C/BE1#		C/BE0#	42
43	C/BE3#		C/BE2#	44
45	AD1		AD0	46
47	AD3		AD2	48
49	AD5		AD4	50
51	AD7		AD6	52
53	AD9		AD8	54
55	AD11		AD10	56
57	AD13		AD12	58
59	AD15		AD14	60
61	AD17		AD16	62
63	AD19		AD18	64
65	AD21		AD20	66
67	AD23		AD22	68
69	AD25		AD24	70
71	AD27		AD26	72
73	AD29	AD28	74	
75	AD31	AD30	76	

Table 5-4. PCI/PMC Expansion Connector (J4) Pin Assignments (continued)

Pin	Signal		Signal	Pin
77	PAR64	GND	Reserved	78
79	C/BE5#		C/BE4#	80
81	C/BE7#		C/BE6#	82
83	AD33		AD32	84
85	AD35		AD34	86
87	AD37		AD36	88
89	AD39		AD38	90
91	AD41		AD40	92
93	AD43		AD42	94
95	AD45		AD44	96
97	AD47		AD46	98
99	AD49		AD48	100
101	AD51		AD50	102
103	AD53		AD52	104
105	AD55		AD54	106
107	AD57		AD56	108
109	AD59		AD58	110
111	AD61		AD60	112
113	AD63		AD62	114

CPU COP Connector (J5)

The processor has a 0.100" COP header for use with the MPC7455 COP controllers.

Table 5-5. CPU COP Connector (J5) Pin Assignments

Pin	Signal	Signal	Pin
1	CPUTDO	QACK_L	2
3	CPUTDI	CPUTRST_L	4
5	QREQ_L	2.5V_VIO	6
7	CPUTCK	OPTPU_2.5v	8
9	CPUTMS	NC	10
11	SRESET_L	NC	12
13	CPURST_L	KEY (no pin)	14
15	CHECKSTPO_L	GND	16

PMC 1 Interface Connectors (J11, J12, J13, J14)

There are four 64-pin SMT connectors for the PMC 1 slot on the MVME5500 to provide a 32/64-bit PCI interface and optional I/O interface.

Note If a PMC module is plugged into PMC slot 1, the memory mezzanine card cannot be used because the PMC module covers the memory mezzanine connector.

Table 5-6. PMC 1 Connector (J11) Pin Assignments

Pin	Signal	Signal	Pin
1	TCK	-12V	2
3	GND	INTA#	4
5	INTB#	INTC#	6
7	PRESENT#	+5V	8
9	INTD#	PCI_RSVD	10
11	GND	+3.3Vaux	12
13	CLK	GND	14
15	GND	GNT#/XREQ0#	16
17	REQ#/XGNT0#	+5V	18
19	VIO	AD31	20
21	AD28	AD27	22
23	AD25	GND	24
25	GND	C/BE3#	26
27	AD22	AD21	28
29	AD19	+5V	30
31	VIO	AD17	32
33	FRAME#	GND	34
35	GND	IRDY#	36
37	DEVSEL#	+5V	38
39	GND	LOCK#	40
41	PCI_RSVD	PCI_RSVD	42
43	PAR	GND	44

Table 5-6. PMC 1 Connector (J11) Pin Assignments

Pin	Signal	Signal	Pin
45	VIO	AD15	46
47	AD12	AD11	48
49	AD09	+5V	50
51	GND	C/BE0#	52
53	AD06	AD05	54
55	AD04	GND	56
57	VIO	AD03	58
59	AD02	AD01	60
61	AD00	+5V	62
63	GND	REQ64#	64

Table 5-7. PMC 1 Connector (J12) Pin Assignments

Pin	Signal	Signal	Pin
1	+12V	TRST#	2
3	TMS	TDO	4
5	TDI	GND	6
7	GND	PCI_RSVD	8
9	PCI_RSVD	PCI_RSVD	10
11	MOT_RSVD	+3.3V	12
13	RST#	MOT_RSVD	14
15	+3.3V	MOT_RSVD	16
17	PME#	GND	18
19	AD30	AD29	20
21	GND	AD26	22
23	AD24	+3.3V	24

Table 5-7. PMC 1 Connector (J12) Pin Assignments

Pin	Signal	Signal	Pin
25	IDSEL	AD23	26
27	+3.3V	AD20	28
29	AD18	GND	30
31	AD16	C/BE2#	32
33	GND	IDSELB	34
35	TRDY#	+3.3V	36
37	GND	STOP#	38
39	PERR#	GND	40
41	+3.3V	SERR#	42
43	C/BE1#	GND	44
45	AD14	AD13	46
47	M66EN	AD10	48
49	AD08	+3.3V	50
51	AD07	REQB_L	52
53	+3.3V	GNTB_L	54
55	MOT_RSVD	GND	56
57	MOT_RSVD	EREADEY	58
59	GND	NC (RESETOUT_L)	60
61	ACK64#	+3.3V	62
63	GND	NC (MONARCH#)	64

Table 5-8. PMC 1 Connector (J13) Pin Assignments

Pin	Signal	Signal	Pin
1	PCI_RSVD	GND	2
3	GND	C/BE7#	4
5	C/BE6#	C/BE5#	6
7	C/BE4#	GND	8
9	VIO	PAR64	10
11	AD63	AD62	12
13	AD61	GND	14
15	GND	AD60	16
17	AD59	AD58	18
19	AD57	GND	20
21	VIO	AD56	22
23	AD55	AD54	24
25	AD53	GND	26
27	GND	AD52	28
29	AD51	AD50	30
31	AD49	GND	32
33	GND	AD48	34
35	AD47	AD46	36
37	AD45	GND	38
39	VIO	AD44	40
41	AD43	AD42	42
43	AD41	GND	44
45	GND	AD40	46
47	AD39	AD38	48
49	AD37	GND	50

Table 5-8. PMC 1 Connector (J13) Pin Assignments

Pin	Signal	Signal	Pin
51	GND	AD36	52
53	AD35	AD34	54
55	AD33	GND	56
57	VIO	AD32	58
59	PCI_RSVD	PCI_RSVD	60
61	PCI_RSVD	GND	62
63	GND	PCI_RSVD	64

Table 5-9. PMC 1 Connector (J14) Pin Assignments

Pin	Signal	Signal	Pin
1	PMC1_1 (P2-C1)	PMC1_2 (P2-A1)	2
3	PMC1_3 (P2-C2)	PMC1_4 (P2-A2)	4
5	PMC1_5 (P2-C3)	PMC1_6 (P2-A3)	6
7	PMC1_7 (P2-C4)	PMC1_8 (P2-A4)	8
9	PMC1_9 (P2-C5)	PMC1_10 (P2-A5)	10
11	PMC1_11 (P2-C6)	PMC1_12 (P2-A6)	12
13	PMC1_13 (P2-C7)	PMC1_14 (P2-A7)	14
15	PMC1_15 (P2-C8)	PMC1_16 (P2-A8)	16
17	PMC1_17 (P2-C9)	PMC1_18 (P2-A9)	18
19	PMC1_19 (P2-C10)	PMC1_20 (P2-A10)	20
21	PMC1_21 (P2-C11)	PMC1_22 (P2-A11)	22
23	PMC1_23 (P2-C12)	PMC1_24 (P2-A12)	24
25	PMC1_25 (P2-C13)	PMC1_26 (P2-A13)	26
27	PMC1_27 (P2-C14)	PMC1_28 (P2-A14)	28
29	PMC1_29 (P2-C15)	PMC1_30 (P2-A15)	30

Table 5-9. PMC 1 Connector (J14) Pin Assignments

Pin	Signal	Signal	Pin
31	PMC1_31 (P2-C16)	PMC1_32 (P2-A16)	32
33	PMC1_33 (P2-C17)	PMC1_34 (P2-A17)	34
35	PMC1_35 (P2-C18)	PMC1_36 (P2-A18)	36
37	PMC1_37 (P2-C19)	PMC1_38 (P2-A19)	38
39	PMC1_39 (P2-C20)	PMC1_40 (P2-A20)	40
41	PMC1_41 (P2-C21)	PMC1_42 (P2-A21)	42
43	PMC1_43 (P2-C22)	PMC1_44 (P2-A22)	44
45	PMC1_45 (P2-C23)	PMC1_46 (P2-A23)	46
47	PMC1_47 (P2-C24)	PMC1_48 (P2-A24)	48
49	PMC1_49 (P2-C25)	PMC1_50 (P2-A25)	50
51	PMC1_51 (P2-C26)	PMC1_52 (P2-A26)	52
53	PMC1_53 (P2-C27)	PMC1_54 (P2-A27)	54
55	PMC1_55 (P2-C28)	PMC1_56 (P2-A28)	56
57	PMC1_57 (P2-C29)	PMC1_58 (P2-A29)	58
59	PMC1_59 (P2-C30)	PMC1_60 (P2-A30)	60
61	PMC1_61 (P2-C31)	PMC1_62 (P2-A31)	62
63	PMC1_63 (P2-C32)	PMC1_64 (P2-A32)	64

Boundary Scan Connector (J18)

The boundary scan connector is used to provide boundary scan testing of all on-board JTAG devices in a single scan chain.

Table 5-10. Boundary Scan Connector (J18) Pin Assignments

Pin	Signal	Signal	Pin
1	TRST_L	GND	2
3	TDO	GND	4
5	TDI	GND	6
7	TMS	GND	8
9	TCK	GND	10
11	NC	GND	12
13	AW	GND	14
15	NC	GND	16
17	NC	GND	18
19	NC	NC	20

PMC 2 Interface Connectors (J21, J22, J23, J24)

There are four 64-pin SMT connectors for the PMC 2 slot on the MVME5500 to provide a 32/64-bit PCI interface and optional I/O interface.

Table 5-11. PMC 2 Connector (J21) Pin Assignments

Pin	Signal	Signal	Pin
1	TCK	-12V	2
3	GND	INTA#	4
5	INTB#	INTC#	6
7	PRESENT#	+5V	8
9	INTD#	PCI_RSVD	10
11	GND	+3.3Vaux	12
13	CLK	GND	14
15	GND	GNT#/XREQ0#	16
17	REQ#/XGNT0#	+5V	18
19	VIO	AD31	20
21	AD28	AD27	22
23	AD25	GND	24
25	GND	C/BE3#	26
27	AD22	AD21	28
29	AD19	+5V	30
31	VIO	AD17	32
33	FRAME#	GND	34
35	GND	IRDY#	36
37	DEVSEL#	+5V	38
39	GND	LOCK#	40
41	PCI_RSVD	PCI_RSVD	42

Table 5-11. PMC 2 Connector (J21) Pin Assignments

Pin	Signal	Signal	Pin
43	PAR	GND	44
45	VIO	AD15	46
47	AD12	AD11	48
49	AD09	+5V	50
51	GND	C/BE0#	52
53	AD06	AD05	54
55	AD04	GND	56
57	VIO	AD03	58
59	AD02	AD01	60
61	AD00	+5V	62
63	GND	REQ64#	64

Table 5-12. PMC 2 Connector (J22) Pin Assignments

Pin	Signal	Signal	Pin
1	+12V	TRST#	2
3	TMS	TDO	4
5	TDI	GND	6
7	GND	PCI_RSVD	8
9	PCI_RSVD	PCI_RSVD	10
11	MOT_RSVD	+3.3V	12
13	RST#	MOT_RSVD	14
15	+3.3V	MOT_RSVD	16
17	PME#	GND	18
19	AD30	AD29	20
21	GND	AD26	22

Table 5-12. PMC 2 Connector (J22) Pin Assignments

Pin	Signal	Signal	Pin
23	AD24	+3.3V	24
25	IDSEL	AD23	26
27	+3.3V	AD20	28
29	AD18	GND	30
31	AD16	C/BE2#	32
33	GND	IDSELB	34
35	TRDY#	+3.3V	36
37	GND	STOP#	38
39	PERR#	GND	40
41	+3.3V	SERR#	42
43	C/BE1#	GND	44
45	AD14	AD13	46
47	M66EN	AD10	48
49	AD08	+3.3V	50
51	AD07	REQB_L	52
53	+3.3V	GNTB_L	54
55	MOT_RSVD	GND	56
57	MOT_RSVD	EREADEY	58
59	GND	NC (RESETOUT_L)	60
61	ACK64#	+3.3V	62
63	GND	NC (MONARCH#)	64

Table 5-13. PMC 2 Connector (J23) Pin Assignments

Pin	Signal	Signal	Pin
1	PCI_RSVD	GND	2
3	GND	C/BE7#	4
5	C/BE6#	C/BE5#	6
7	C/BE4#	GND	8
9	VIO	PAR64	10
11	AD63	AD62	12
13	AD61	GND	14
15	GND	AD60	16
17	AD59	AD58	18
19	AD57	GND	20
21	VIO	AD56	22
23	AD55	AD54	24
25	AD53	GND	26
27	GND	AD52	28
29	AD51	AD50	30
31	AD49	GND	32
33	GND	AD48	34
35	AD47	AD46	36
37	AD45	GND	38
39	VIO	AD44	40
41	AD43	AD42	42
43	AD41	GND	44
45	GND	AD40	46
47	AD39	AD38	48
49	AD37	GND	50

Table 5-13. PMC 2 Connector (J23) Pin Assignments

Pin	Signal	Signal	Pin
51	GND	AD36	52
53	AD35	AD34	54
55	AD33	GND	56
57	VIO	AD32	58
59	PCI_RSVD	PCI_RSVD	60
61	PCI_RSVD	GND	62
63	GND	PCI_RSVD	64

Table 5-14. PMC 2 Connector (J24) Pin Assignments

Pin	Signal	Signal	Pin
1	PMC2_1 (P2-D1)	PMC2_2 (P2-Z1)	2
3	PMC2_3 (P2-D2)	PMC2_4 (P2-D3)	4
5	PMC2_5 (P2-Z3)	PMC2_6 (P2-D4)	6
7	PMC2_7 (P2-D5)	PMC2_8 (P2-Z5)	8
9	PMC2_9 (P2-D6)	PMC2_10 (P2-D7)	10
11	PMC2_11 (P2-Z7)	PMC2_12 (P2-D8)	12
13	PMC2_13 (P2-D9)	PMC2_14 (P2-Z9)	14
15	PMC2_15 (P2-D10)	PMC2_16 (P2-D11)	16
17	PMC2_17 (P2-Z11)	PMC2_18 (P2-D12)	18
19	PMC2_19 (P2-D13)	PMC2_20 (P2-Z13)	20
21	PMC2_21 (P2-D14)	PMC2_22 (P2-D15)	22
23	PMC2_23 (P2-Z15)	PMC2_24 (P2-D16)	24
25	PMC2_25 (P2-D17)	PMC2_26 (P2-Z17)	26
27	PMC2_27 (P2-D18)	PMC2_28 (P2-D19)	28
29	PMC2_29 (P2-Z19)	PMC2_30 (P2-D20)	30

Table 5-14. PMC 2 Connector (J24) Pin Assignments

Pin	Signal	Signal	Pin
31	PMC2_31 (P2-D21)	PMC2_32 (P2-Z21)	32
33	PMC2_33 (P2-D22)	PMC2_34 (P2-D23)	34
35	PMC2_35 (P2-Z23)	PMC2_36 (P2-D24)	36
37	PMC2_37 (P2-D25)	PMC2_38 (P2-Z25)	38
39	PMC2_39 (P2-D26)	PMC2_40 (P2-D27)	40
41	PMC2_41 (P2-Z27)	PMC2_42 (P2-D28)	42
43	PMC2_43 (P2-D29)	PMC2_44 (P2-Z29)	44
45	PMC2_45 (P2-D30)	PMC2_46 (P2-Z31)	46
47	Not Used	Not Used	48
49	Not Used	Not Used	50
51	Not Used	Not Used	52
53	Not Used	Not Used	54
55	Not Used	Not Used	56
57	Not Used	Not Used	58
59	Not Used	Not Used	60
61	Not Used	Not Used	62
63	Not Used	Not Used	64

Asynchronous Serial Port (COM2) Planar Connector (J33)

A 10-pin 0.100" planar connector provides the interface to a second asynchronous serial debug port. The pin assignments for this connector are as follows:

Table 5-15. COM2 Planar Connector (J33) Pin Assignments

Pin	Signal	Signal	Pin
1	COM2_DCD	COM2_DSR	2
3	COM2_RX	COM2_RTS	4
5	COM2_TX	COM2_CTS	6
7	COM2_DTR	COM2_RI	8
9	GND	KEY (no pin)	10

VMEbus Connectors (P1 & P2) (PMC Mode)

The VME P1 and P2 connectors are 160-pin DINs. The P1 connector provides power and VME signals for 24-bit address and 16-bit data. The pin assignments for the P1 connector are specified by the *VME64 Extension Standard* (refer to [Appendix D, Related Documentation](#), for the link to this specification).

Row B of the P2 connector provides power to the MVME5500 and to the upper eight VMEbus address lines, and additional 16 VMEbus data lines. The pin assignments for the P2 connector are as follows:



When J28 is configured for IPMC mode, -12V is supplied to P2 pin A30. If there is an incompatible board plugged into this P2 slot, damage may occur.

When J32 is configured for IPMC mode, +12V is supplied to P2 pin C7. If there is an incompatible board plugged into this P2 slot, damage may occur.

J102 – J110 should be configured for PMC 2 I/O to connect PMC slot 2 user I/O from J24 to the P2 connector.

Table 5-16. VME Connector (P2) Pin Assignments (PMC Mode)

Pin	ROW Z	ROW A	ROW B	ROW C	ROW D
1	PMC2_2 (J24-2)	PMC1_2 (J14-2)	+5V	PMC1_1 (J14-1) /P2_RX-	PMC2_1 (J24-1)
2	GND	PMC1_4 (J14-4)	GND	PMC1_3 (J14-3) /P2_RX+	PMC2_3 (J24-3)
3	PMC2_5 (J24-5)	PMC1_6 (J14-6)	RETRY# (No connect)	PMC1_5 (J14-5) /P2_TX-	PMC2_4 (J24-4)
4	GND	PMC1_8 (J14-8)	VA24	PMC1_7 (J14-7) /P2_TX+	PMC2_6 (J24-6)
5	PMC2_8 (J24-8)	PMC1_10 (J14-10)	VA25	PMC1_9 (J14-9)	PMC2_7 (J24-7)
6	GND	PMC1_12 (J14-12)	VA26	PMC1_11 (J14-11)	PMC2_9 (J24-9)
7	PMC2_11 (J24-11)	PMC1_14 (J14-14)	VA27	PMC1_13 (J14-13)	PMC2_10 (J24-10)
8	GND	PMC1_16 (J14-16)	VA28	PMC1_15 (J14-15)	PMC2_12 (J24-12)
9	PMC2_14 (J24-14)	PMC1_18 (J14-18)	VA29	PMC1_17 (J14-17)	PMC2_13 (J24-13)
10	GND	PMC1_20 (J14-20)	VA30	PMC1_19 (J14-19)	PMC2_15 (J24-15)
11	PMC2_17 (J24-17)	PMC1_22 (J14-22)	VA31	PMC1_21 (J14-21)	PMC2_16 (J24-16)
12	GND	PMC1_24 (J14-24)	GND	PMC1_23 (J14-23)	PMC2_18 (J24-18)
13	PMC2_20 (J24-20)	PMC1_26 (J14-26)	+5V	PMC1_25 (J14-25)	PMC2_19 (J24-19)

Table 5-16. VME Connector (P2) Pin Assignments (PMC Mode)

Pin	ROW Z	ROW A	ROW B	ROW C	ROW D
14	GND	PMC1_28 (J14-28)	VD16	PMC1_27 (J14-27)	PMC2_21 (J24-21)
15	PMC2_23 (J24-23)	PMC1_30 (J14-30)	VD17	PMC1_29 (J14-29)	PMC2_22 (J24-22)
16	GND	PMC1_32 (J14-32)	VD18	PMC1_31 (J14-31)	PMC2_24 (J24-24)
17	PMC2_26 (J24-26)	PMC1_34 (J14-34)	VD19	PMC1_33 (J14-33)	PMC2_25 (J24-25)
18	GND	PMC1_36 (J14-36)	VD20	PMC1_35 (J14-35)	PMC2_27 (J24-27)
19	PMC2_29 (J24-29)	PMC1_38 (J14-38)	VD21	PMC1_37 (J14-37)	PMC2_28 (J24-28)
20	GND	PMC1_40 (J14-40)	VD22	PMC1_39 (J14-39)	PMC2_30 (J24-30)
21	PMC2_32 (J24-32)	PMC1_42 (J14-42)	VD23	PMC1_41 (J14-41)	PMC2_31 (J24-31)
22	GND	PMC1_44 (J14-44)	GND	PMC1_43 (J14-43)	PMC2_33 (J24-33)
23	PMC2_35 (J24-35)	PMC1_46 (J14-46)	VD24	PMC1_45 (J14-45)	PMC2_34 (J24-34)
24	GND	PMC1_48 (J14-48)	VD25	PMC1_47 (J14-47)	PMC2_36 (J24-36)
25	PMC2_38 (J24-38)	PMC1_50 (J14-50)	VD26	PMC1_49 (J14-49)	PMC2_37 (J24-37)
26	GND	PMC1_52 (J14-52)	VD27	PMC1_51 (J14-51)	PMC2_39 (J24-39)
27	PMC2_41 (J24-41)	PMC1_54 (J14-54)	VD28	PMC1_53 (J14-53)	PMC2_40 (J24-40)
28	GND	PMC1_56 (J14-56)	VD29	PMC1_55 (J14-55)	PMC2_42 (J24-42)

Table 5-16. VME Connector (P2) Pin Assignments (PMC Mode)

Pin	ROW Z	ROW A	ROW B	ROW C	ROW D
29	PMC2_44 (J24-44)	PMC1_58 (J14-58)	VD30	PMC1_57 (J14-57)	PMC2_43 (J24-43)
30	GND	PMC1_60 (J14-60)	VD31	PMC1_59 (J14-59)	PMC2_45 (J24-45)
31	PMC2_46 (J24-46)	PMC1_62 (J14-62)	GND	PMC1_61 (J14-61)	GND
32	GND	PMC1_64 (J14-64)	+5V	PMC1_63 (J14-63)	+5V

VMEbus Connectors (P1 & P2) (SBC Mode)

The VME P1 and P2 connectors are 160-pin DINs. The P1 connector provides power and VME signals for 24-bit address and 16-bit data. The pin assignments for the P1 connector are specified by the *VME64 Extension Standard* (refer to [Appendix D, Related Documentation](#), for the link to this specification).

Row B of the P2 connector provides power to the MVME5500 and to the upper eight VMEbus address lines, and additional 16 VMEbus data lines. The pin assignments for the P2 connector are as follows:



Warning

When J28 is configured for IPMC mode, -12V is supplied to P2 pin A30. If there is an incompatible board plugged into this P2 slot, damage may occur.

When J32 is configured for IPMC mode, +12V is supplied to P2 pin C7. If there is an incompatible board plugged into this P2 slot, damage may occur.

J102 – J110 should be configured for IPMC I/O to connect the IPMC extended SCSI signals from J3 to the P2 connector.

Table 5-17. VME Connector (P2) Pinout with IPMC712

Pin	Row Z	Row A	Row B	Row C	Row D
1	PMC2_2	DB0#	+5V	C- (10/100)	PMC2_1 (J24-1)
2	GND	DB1#	GND	C+ (10/100)	PMC2_3 (J24-3)
3	PMC2_5	DB2#	N/C	T- (10/100)	PMC2_4 (J24-4)
4	GND	DB3#	VA24	T+ (10/100)	PMC2_6 (J24-6)
5	PMC2_8	DB4#	VA25	R-	PMC2_7 (J24-7)
6	GND	DB5#	VA26	R+	PMC2_9 (J24-9)
7	PMC2_11	DB6#	VA27	+12V (LAN)	PMC2_10 (J24-10)
8	GND	DB7#	VA28	PRSTB#	PMC2_12 (J24-12)
9	PMC2-14	DBP#	VA29	P DB0	PMC2_13 (J24-13)
10	GND	ATN#	VA30	P DB1	PMC2_15 (J24-15)
11	PMC2_17	BSY#	VA31	P DB2	PMC2_16 (J24-16)
12	GND	ACK#	GND	P DB3	PMC2_18 (J24-18)
13	PMC2_20	RST#	+5V	P DB4	PMC2_19 (J24-19)
14	GND	MSG#	VD16	P DB5	PMC2_21 (J24-21)
15	PMC2_23	SEL#	VD17	P DB6	PMC2_22 (J24-22)
16	GND	D/C#	VD18	P DB7	PMC2_24 (J24-24)
17	PMC2_26	REQ#	VD19	P ACK#	PMC2_25 (J24-25)
18	GND	I/O#	VD20	P BSY	PMC2_27 (J24-27)
19	PMC2_29 (J24-29)	TXD3	VD21	P PE	PMC2_28 (J24-28)
20	GND	RXD3	VD22	P SEL	PMC2_30 (J24-30)
21	PMC2_32 (J24-32)	RTS3	VD23	P IME	PMC2_31 (J24-31)
22	GND	CTS3	GND	P FAULT#	PMC2_33 (J24-33)

Table 5-17. VME Connector (P2) Pinout with IPMC712 (continued)

Pin	Row Z	Row A	Row B	Row C	Row D
23	PMC2_35 (J24-35)	DTR3	VD24	TXD1_232	PMC2_34 (J24-34)
24	GND	DCD3	VD25	RXD1	PMC2_36 (J24-36)
25	PMC2_38 (J24-38)	TXD4	VD26	RTS1	PMC2_37 (J24-37)
26	GND	RXD4	VD27	CTS1	PMC2_39 (J24-39)
27	PMC2_41 (J24-41)	RTS4	VD28	TXD2	PMC2_40 (J24-40)
28	GND	TRXC4	VD29	RXD2	PMC2_42 (J24-42)
29	PMC2_44 (J24-44)	CTS4	VD30	RTS2	PMC2_43 (J24-43)
30	GND	DTR4	VD31	CTS2	PMC2_45 (J24-45)
31	PMC2_46 (J24-46)	DCD4	GND	DTR2	GND
32	GND	RTXC4	+5V	DCD2	VPC

5

Table 5-18. VME Connector (P2) Pinouts with IPMC761

Pin	Row Z	Row A	Row B	Row C	Row D
1	DB8#	DB0#	+5V	RD- (10/100)	PMC2_1 (J24-1)
2	GND	DB1#	GND	RD+ (10/100)	PMC2_3 (J24-3)
3	DB9#	DB2#	RETRY#	TD- (10/100)	PMC2_4 (J24-4)
4	GND	DB3#	VA24	TD+ (10/100)	PMC2_6 (J24-6)
5	DB10#	DB4#	VA25	Not Used	PMC2_7 (J24-7)
6	GND	DB5#	VA26	Not Used	PMC2_9 (J24-9)
7	DB11#	DB6#	VA27	+12VF	PMC2_10 (J24-10)
8	GND	DB7#	VA28	PRSTB#	PMC2_12 (J24-12)
9	DB12#	DBP#	VA29	PRD0	PMC2_13 (J24-13)
10	GND	ATN#	VA30	PRD1	PMC2_15 (J24-15)
11	DB13#	BSY#	VA31	PRD2	PMC2_16 (J24-16)
12	GND	ACK#	GND	PRD3	PMC2_18 (J24-18)

Table 5-18. VME Connector (P2) Pinouts with IPMC761 (continued)

Pin	Row Z	Row A	Row B	Row C	Row D
13	DB14#	RST#	+5V	PRD4	PMC2_19 (J24-19)
14	GND	MSG#	VD16	PRD5	PMC2_21 (J24-21)
15	DB15#	SEL#	VD17	PRD6	PMC2_22 (J24-22)
16	GND	D/C#	VD18	PRD7	PMC2_24 (J24-24)
17	DBP1#	REQ#	VD19	PRACK#	PMC2_25 (J24-25)
18	GND	O/I#	VD20	PRBSY	PMC2_27 (J24-27)
19	PMC2_29 (J24-29)	AFD#	VD21	PRPE	PMC2_28 (J24-28)
20	GND	SLIN#	VD22	PRSEL	PMC2_30 (J24-30)
21	PMC2_32 (J24-32)	TXD3	VD23	INIT#	PMC2_31 (J24-31)
22	GND	RXD3	GND	PRFLT#	PMC2_33 (J24-33)
23	PMC2_35 (J24-35)	RTXC3	VD24	TXD1_232	PMC2_34 (J24-34)
24	GND	TRXC3	VD25	RXD1_232	PMC2_36 (J24-36)
25	PMC2_38 (J24-38)	TXD4	VD26	RTS1_232	PMC2_37 (J24-37)
26	GND	RXD4	VD27	CTS1_232	PMC2_39 (J24-39)
27	PMC2_41 (J24-41)	RTXC4	VD28	TXD2_232	PMC2_40 (J24-40)
28	GND	TRXC4	VD29	RXD2_232	PMC2_42 (J24-42)
29	PMC2_44 (J24-44)		VD30	RTS2_232	PMC2_43 (J24-43)
30	GND	-12VF	VD31	CTS2_232	PMC2_45 (J24-45)
31	PMC2_46 (J24-46)	MSYNC#	GND	MDO	GND
32	GND	MCLK	+5V	MDI	VPC

Note Rows A and C and Z's (Z1, 3, 5, 7, 9, 11, 13, 15, and 17) functionality is provided by the IPMC761 in slot 1 and the MVME5500 Ethernet port 2.

Memory Expansion Connector (P4)

One 140-pin connector is used to provide memory expansion capability. This connector interfaces to up to two additional banks of memory. The pin assignments for this connector are as follows:

Note If a PMC module is plugged into PMC slot 1, the memory mezzanine card cannot be used because the PMC module covers the memory mezzanine connector.

Table 5-19. Memory Expansion Connector (P4) Pin Assignments

Pin	Signal	Signal	Pin
1	GND	GND	2
3	MD0	MD1	4
5	MD2	MD3	6
7	MD4	MD5	8
9	MD6	MD7	10
11	+3.3V	+3.3V	12
13	MD8	MD9	14
15	MD10	MD11	16
17	MD12	MD13	18
19	MD14	MD15	20
21	GND	GND	22
23	MD16	MD17	24
25	MD18	MD19	26
27	MD20	MD21	28

Table 5-19. Memory Expansion Connector (P4) Pin Assignments (continued)

Pin	Signal	Signal	Pin
29	MD22	MD23	30
31	+3.3V	+3.3V	32
33	MD24	MD25	34
35	MD26	MD27	36
37	MD28	MD29	38
39	MD30	MD31	40
41	GND	GND	42
43	MD32	MD33	44
45	MD34	MD35	46
47	MD36	MD37	48
49	MD38	MD39	50
51	+3.3V	+3.3V	52
53	MD40	MD41	54
55	MD42	MD43	56
57	MD44	MD45	58
59	MD46	MD47	60
61	GND	GND	62
63	MD48	MD49	64
65	MD50	MD51	66
67	MD52	MD53	68
69	+3.3V	+3.3V	70
71	MD54	MD55	72
73	MD56	MD57	74
75	MD58	MD59	76
77	MD60	MD61	78

Table 5-19. Memory Expansion Connector (P4) Pin Assignments (continued)

Pin	Signal	Signal	Pin
79	GND	GND	80
81	MD62	MD63	82
83	MPAR0	MPAR1	84
85	MPAR2	MPAR3	86
87	MPAR4	MPAR5	88
89	+3.3V	+3.3V	90
91	MPAR6	MPAR7	92
93	BA0#	BA1#	94
95	MA12	MA11	96
97	MA10	MA9	98
99	GND	GND	100
101	MA8	MA7	102
103	MA6	MA5	104
105	MA4	MA3	106
107	MA2	MA1	108
109	+3.3V	+3.3V	110
111	MA0	B2_CS#	112
113	B3_CS#	GND	114
115	DQM5	DQM7	116
117	SDWE#	SDRAS#	118
119	GND	GND	120
121	SDCAS#	+3.3V	122
123	+3.3V	DQM6	124
125	DQM5	I2CSCL	126
127	I2CSDA	A1_SPD (GND)	128

Table 5-19. Memory Expansion Connector (P4) Pin Assignments (continued)

Pin	Signal	Signal	Pin
129	A0_SPD (NC)	DQM4	130
131	DQM3	DQM2	132
133	GND	CLK_MEZZ	134
135	GND	+3.3V	136
137	DQM1	DQM0	138
139	GND	GND	140

Headers

Ethernet 2, PMC/SBC Mode, and P2 I/O Selection Headers (J6, J7, J28, J32, J34, J97 – J110)

All of the headers described below are used in conjunction with each other to select various modes of operation for 10/100BaseT Ethernet, PMC/SBC mode, and P2 I/O mode.

Ethernet

Four 3-pin 2 mm planar headers and four 2-pin 2 mm planar headers are for 10/100/BaseT Ethernet 2 selection. *Ethernet 1 is the Gigabit Ethernet port and is front panel only.* The pin assignments for these headers are as follows:

Table 5-20. Ethernet 2 Selection Headers (J6, J7, J100, J101) Pin Assignments

10/100 Ethernet Receive Pairs		10/100 Ethernet Transmit Pairs	
J6		J7	
Pin	Signal	Signal	Pin
1	FP_RX-	FP_TX+	1
2	RX-	TX+	2
3	P2_RX-	P2_TX+	3
J100		J101	
1	FP_RX+	FP_TX-	4
2	RX+	TX-	5
3	P2_RX+	P2_TX-	6

For rear P2 Ethernet, install jumpers across pins 2-3 on all four headers (J6, J7, J100, and J101). For front-panel Ethernet, install jumpers across pins 1-2 on all four headers.

Note If the rear P2 Ethernet is selected by jumpers J6, J7, J100, and J101, the Ethernet signals also connect to PMC 1 user I/O connector J14. If a PMC card is plugged into PMC 1, there may be a conflict between the I/O from the PMC card and the rear Ethernet signals. This conflict does not occur with the IPMC761 or IPMC712 modules.

Table 5-21. Ethernet 2 Selection Headers (J34, J97, J98, J99) Pin Assignments

Pin	Signal		Pin	Signal
J34			J97	
1	PMC1_IO(7)		1	PMC1_IO (5)
2	P2_TX+		2	P2_TX-
J98			J99	
1	PMC1_IO(3)		1	PMC1_IO (1)
2	P2_RX+		2	P2_RX-

For rear P2 Ethernet, install jumpers on all four headers (J34, J97, J98, and J99) when in SBC/IPMC761 mode. No jumpers are installed for front-panel Ethernet.

PMC/SBC Mode Selection

Two 3-pin planar headers on the MVME5500 are for PMC/SBC mode selection. For PMC mode, install jumpers across pins 1-2 on both headers. For SBC/IPMC761 mode, install jumpers across pins 2-3 on both headers. For SBC/IPMC712 mode, install a jumper across pins 2-3 for J32 and

install a jumper across pins 1-2 for J28. The pin assignments for these headers are as follows:

**Table 5-22. PMC/SBC Mode Selection Headers (J28, J32)
Pin Assignments**

J28			J32	
Pin	Signal		Pin	Signal
1	Fused -12.0V		1	Fused +12.0V
2	P2_PMC1_IO (60)		2	P2_PMC1_IO (13)
3	PMC1_IO(60)		3	PMC1_IO(13)



Warning

When J28 is configured for SBC/IPMC mode, -12V is supplied to P2 pin A30. If there is an incompatible board plugged into this P2 slot, damage may occur.

When J32 is configured for SBC/IPMC mode, +12V is supplied to P2 pin C7. If there is an incompatible board plugged into this P2 slot, damage may occur.

Install jumpers across pins 1-2 on both headers to select PMC mode. Install jumpers across pins 2-3 on both headers to select SBC/IPMC761 mode. Install a jumper across pins 2-3 on J32 and install a jumper across pins 1-2 on J28 to select SBC/IPMC712 mode.

P2 I/O Selection

Nine 3-pin 2 mm planar headers are for P2 I/O selection. Install jumpers across pins 1-2 on all nine headers to select PMC 2 I/O for P2 in PMC mode. Install jumpers across pins 2-3 on all nine headers to select IPMC

I/O for P2 in SBC/IPMC761 or SBC/IPMC712 mode. The pin assignments for these headers are as follows:

Table 5-23. P2 I/O Selection Headers (J102 – J110) Pin Assignments

Pin	Signal		Pin	Signal
J102			J103	
1	PMC2_IO (2)		1	PMC2_IO (5)
2	P2_PMC2_IO (2)		2	P2_PMC2_IO (5)
3	IPMC_DB8_L		3	IPMC_DB9_L
J104			J105	
1	PMC2_IO (8)		1	PMC2_IO (11)
2	P2_PMC2_IO (8)		2	P2_PMC2_IO (11)
3	IPMC_DB10_L		3	IPMC_DB11_L
J106			J107	
1	PMC2_IO (14)		1	PMC2_IO (17)
2	P2_PMC2_IO (14)		2	P2_PMC2_IO (17)
3	IPMC_DB12_L		3	IPMC_DB13_L
J108			J109	
1	PMC2_IO (20)		1	PMC2_IO (23)
2	P2_PMC2_IO (20)		2	P2_PMC2_IO (23)
3	IPMC_DB14_L		3	IPMC_DB15_L
J110				
1	PMC2_IO (26)			
2	P2_PMC2_IO (26)			
3	IPMC_DBP1_L			

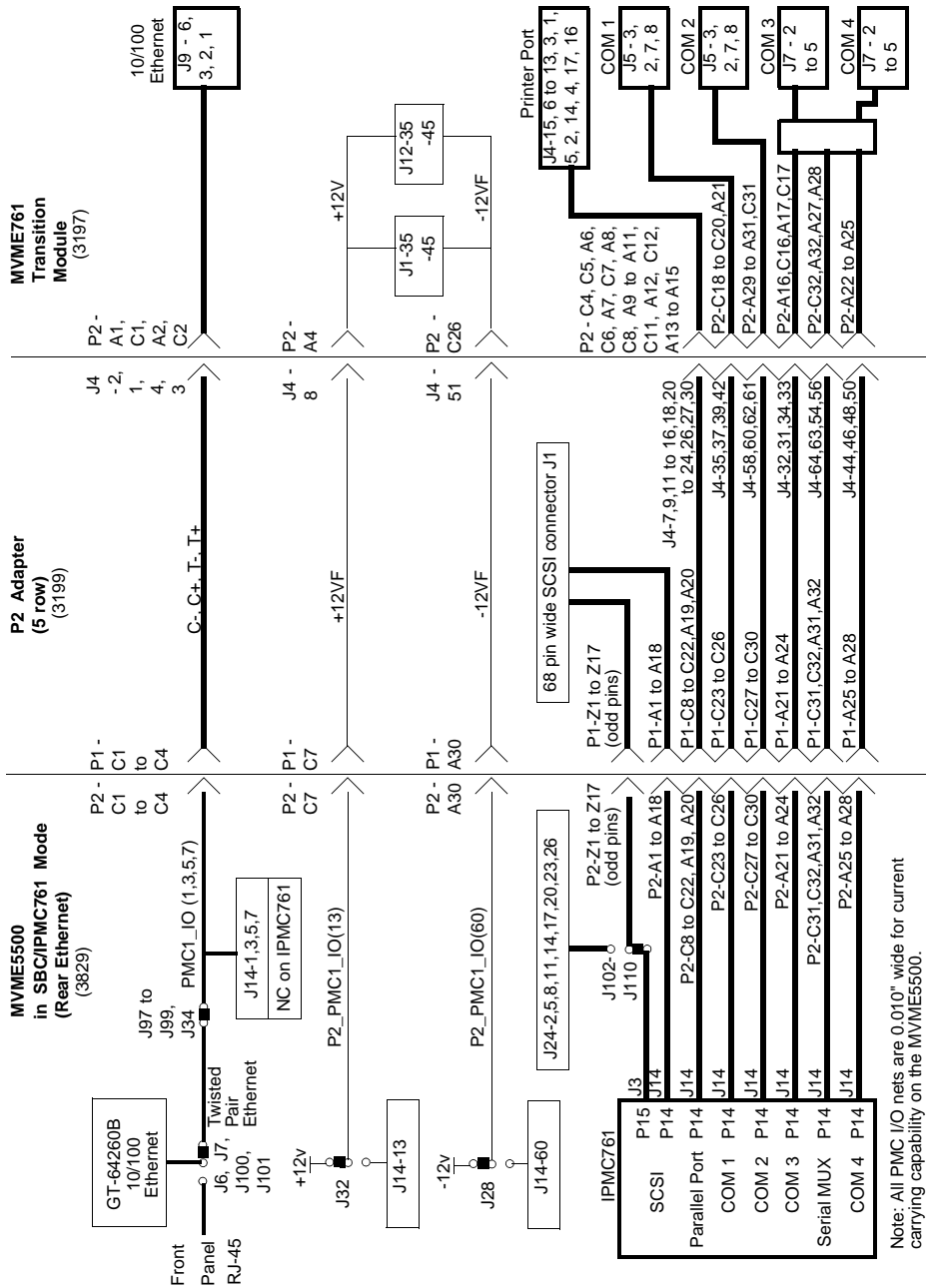
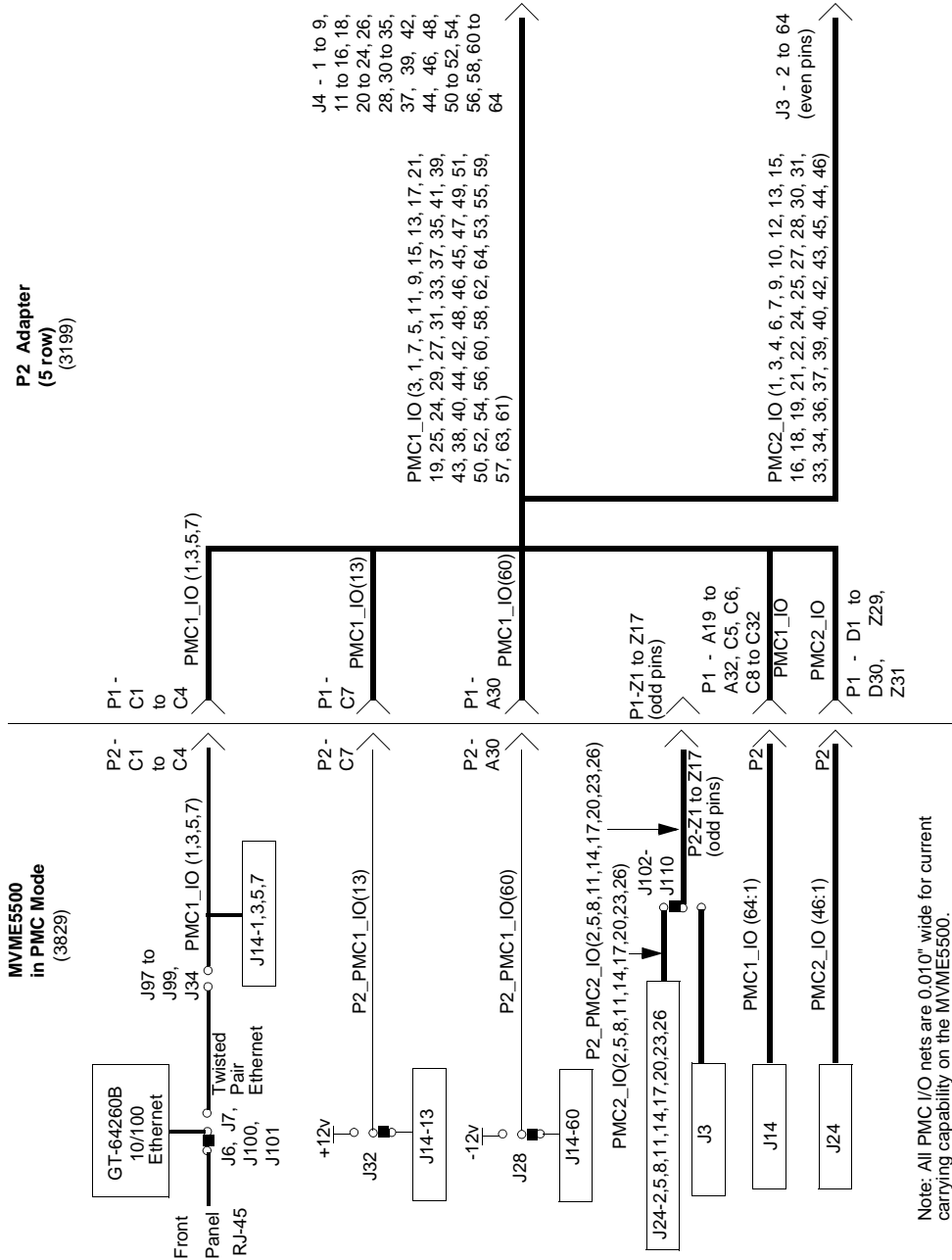

Figure 5-2. SBC/IPMC761 Mode

Note: All PMC I/O nets are 0.010" wide for current carrying capability on the MVME5500.



Note: All PMC I/O nets are 0.010" wide for current carrying capability on the MVME5500.

Figure 5-3. PMC Mode

Flash Boot Bank Select Header (J8)

A 3-pin 2 mm planar header selects the boot Flash bank. No jumper or a jumper installed across pins 1-2 selects Flash 0 as the boot bank. A jumper installed across pins 2-3 selects Flash 1 as the boot bank. The pin assignments for this header are as follows:

Table 5-24. Flash Boot Bank Select Header (J8) Pin Assignments

Pin	Signal
1	GND
2	BANK_SEL
3	+3.3V

5

Flash 0 Programming Enable Header (J9)

A 2-pin 2 mm planar header enables/disables programming of Flash 0 as a means of protecting the contents from being corrupted. No jumper installed disables all Flash 0 programming. The jumper must be installed in order to erase array blocks, programming data, or configuring lock-bits. The pin assignments for this header are as follows:

Table 5-25. Flash 0 Programming Enable Header (J9) Pin Assignments

Pin	Signal
1	+3.3V
2	VPEN

Safe Start ENV Header (J10)

A 3-pin 2 mm planar header selects programmed or safe start ENV settings. No jumper or a jumper across pins 1-2 indicates that the programmed ENV settings should be used during boot. A jumper across pins 2-3 indicates that the safe ENV settings should be used. The pin assignments for this header are as follows:

Table 5-26. Safe Start ENV Header (J10) Pin Assignments

Pin	Signal
1	GND
2	SAFE_START
3	+3.3V

Flash 0 Block Write Protect Header (J15)

A 2-pin 2 mm planar header supports the Intel K3 Flash family write protect feature. No jumper installed enables the lock-down mechanism. Blocks locked down cannot be unlocked with the unlock command. The jumper must be installed in order to override the lock-down function and enable blocks to be erased or programmed through software. Refer to the *Intel K3 Flash data sheet* for further details. The pin assignments for this header are as follows:

Table 5-27. Flash 0 Write Protect Header (J15) Pin Assignments

Pin	Signal
1	+3.3V
2	WP_L

SROM Initialization Enable Header (J17)

A 3-pin 2 mm planar header enables/disables the GT-64260B SROM initialization. No jumper or a jumper across pins 1-2 enables the GT-64260B device initialization via I2C SROM while a jumper across pins 2-3 disables this initialization sequence. The pin assignments for this header are as follows:

Table 5-28. SROM Initialization Enable Header (J17) Pin Assignments

Pin	Signal
1	+3.3V
2	SROM_INIT
3	GND

Bus Mode Select Header (J19)

A 3-pin 2 mm planar header selects the processor bus operating mode. No jumper or a jumper across pins 1-2 selects the 60x bus mode while a jumper across pins 2-3 selects the MPX bus mode. The pin assignments for this header are as follows:

Table 5-29. Bus Mode Header (J19) Pin Assignments

Pin	Signal
1	GND
2	BUS_MODE
3	+3.3V

COP Enable Header (J20)

A 2-pin 2 mm planar header enables the Riscwatch capability. A jumper installed enables the Riscwatch. Remove the jumper to provide boundary scan access for lab use. The pin assignments for this header are as follows:

Table 5-30. COP Enable Header (J20) Pin Assignments

Pin	Signal
1	COP_EN_L
2	GND

PCI Bus 0.0 Speed Header (J25)

A 2-pin 2 mm planar header provides the capability to force PCI Bus 0.0 to run at 33 MHz rather than allowing the PMC to control the bus to run at 33 or 66 MHz. No jumper installed allows the PMC to choose the PCI Bus 0.0 speed. A jumper installed across pins 1-2 forces PCI Bus 0.0 to run at 33 MHz. The pin assignments for this header are as follows:

Table 5-31. PCI Bus 0.0 Speed Header (J25) Pin Assignments

Pin	Signal
1	P0_M66EN
2	GND

VME SCON Select Header (J27)

A 3-pin 2 mm planar header allows the choice for auto/enable/disable SCON VME configuration. A jumper installed across pins 1-2 configures for SCON disabled. A jumper installed across pins 2-3 configures for auto SCON. No jumper installed configures for SCON always enabled. The pin assignments for this header are as follows:

Table 5-32. VME SCON Select Header (J27) Pin Assignments

Pin	Signal
1	No SCON
2	SCON
3	Auto-SCON

PCI Bus 1.0 Speed Header (J29)

A 2-pin 2 mm planar header provides the capability to force PCI Bus 1.0 to run at 33 MHz rather than allowing the PMC to control the bus to run at 33 or 66 MHz. No jumper installed allows the PMC to choose the PCI Bus 1.0 speed. A jumper installed across pins 1-2 forces PCI Bus 1.0 to run at 33 MHz. The pin assignments for this header are as follows:

Table 5-33. PCI Bus 1.0 Speed Header (J25) Pin Assignments

Pin	Signal
1	P1_M66EN
2	GND

EEPROM Write Protect Header (J30)

A 2-pin 2 mm planar header enables/disables programming of the on-board EEPROMs as a means of protecting the contents from being corrupted. No jumper installed disables EEPROM programming by driving the WP pin to a logic high. The jumper must be installed in order to program any of the EEPROMs at addresses A0, A6, A8, and/or AA. The pin assignments for this header are as follows:

Table 5-34. EEPROM Write Protect Header (J30) Pin Assignments

Pin	Signal
1	I2CWP
2	GND

Power Requirements

In its standard configuration, the MVME5500 requires +5V, +12V, and -12V for operation. On-board converters supply the processor core voltage, +3.3V, +1.5V, +1.8V, and +2.5V.

Supply Current Requirements

[Table A-1](#) provides an estimate of the typical and maximum current required from each of the input supply voltages.

Table A-1. Power Requirements

Model	Power
MVME5500-0163	Typical: 6.62 A @ +5V Maximum: 7.94 A @ +5V
MVME5500-0163 with memory mezzanine	Typical: 7.46A @ +5V Maximum: 8.96 A @ +5V
MVME5500-0163 with IPMC712/761	Typical: 7.60 A @ +5V Maximum: 9.12 A @ +5V

Note In a 3-row chassis, PMC current should be limited to 19.8 watts (total of both PMC slots). In a 5-row chassis, PMC current should be limited to 46.2 watts (total of both PMC slots).

Environmental Specifications

Table A-2 lists the environmental specifications, along with the board dimensions.

Table A-2. MVME5500 Specifications

Characteristics	Specifications
Operating Temperature	0° to +55° C (forced air cooling required) 400 LFM (linear feet per minute) of forced air cooling is recommended for operation in the upper temperature range.
Storage Temperature	-40° to 70° C
Relative Humidity	Operating: 5% to 90% non-condensing Non-operating: 5% to 95% non-condensing
Vibration	Non-operating: 1 G sine sweep, 5–100 Hz, horizontal and vertical (NEBS1)
Physical Dimensions	6U, 4HP wide (233 mm x 160 mm x 20 mm)
MTBF	207,058 hours

RAM5500 Memory Expansion Module

B

Overview

The RAM5500 memory expansion module can be used on the MVME5500 as an option for additional memory capability. The expansion module has two banks of SDRAM with up to 512MB of available ECC memory. The RAM5500 incorporates a serial ROM (SROM) for system memory serial presence detect (SPD) data.

Features

The following table lists the features of the RAM5500 memory expansion module:

Table B-1. RAM5500 Feature Summary

Form Factor	Dual-sided mezzanine
SROM	Single 256 x 8 I2C SROM for SPD data
SDRAM	Double-bit error detect, single-bit error correct across 72 bits; 512MB mezzanine memory (two banks of 256MB memory in each) at 133 MHz

Functional Description

The following sections describe the physical and electrical structure of the RAM5500 memory expansion module.

RAM5500 Description

The RAM5500 is a memory expansion module that is used on the MVME5500 single board computer. It is based on a single memory

B

mezzanine board design with two banks of memory. Each bank is 256MB of ECC memory using 256Mb devices in 32MB x 8 device organization.

The RAM5500 provides a total added capacity of 512MB to the MVME5500. The SDRAM memory is controlled by the GT-64260B, which provides single-bit error correction and double-bit error detection. ECC is calculated over 72-bits. The on-board I2C SROM contains SPD data for the two banks, which is used by the memory controller for configuration. Refer to the *MVME5500 Single Board Computer Programmer's Reference Guide (V5500A/PG)* for more information.

The RAM5500 memory expansion module is connected to the host board with a 140-pin AMP 4mm Free Height plug connector. This memory expansion module draws +3.3V through this connector.

The RAM5500 SPD uses the SPD JEDEC standard definition and is accessed at address \$A2. Refer to the following section on SROM for more details.

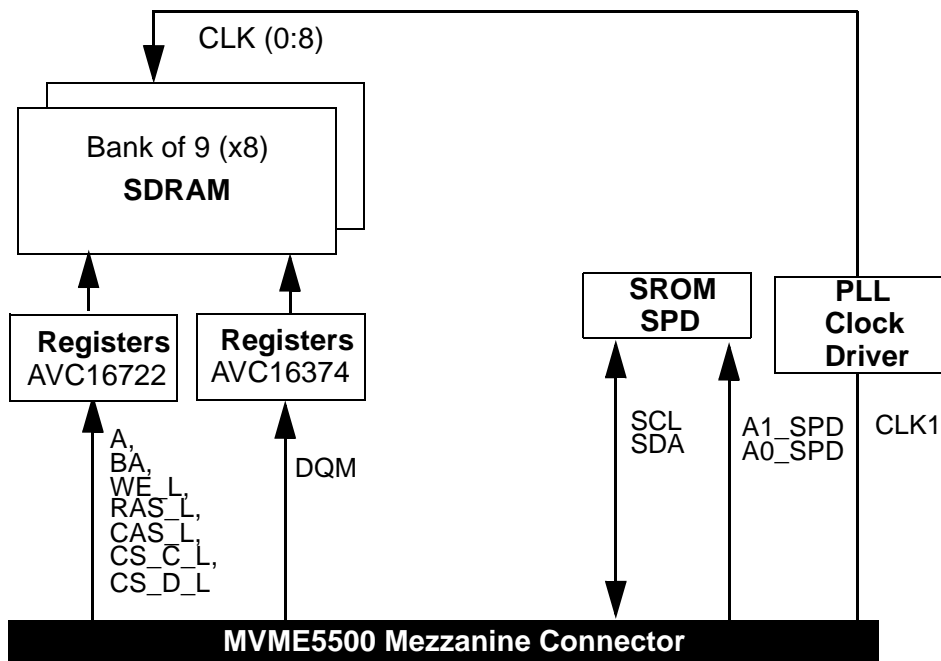

Figure B-1. RAM5500 Block Diagram

SROM

B

The RAM5500 memory expansion module contains a single 3.3V, 256 x 8, serial EEPROM device (AT24C02). The serial EEPROM provides SPD storage of the module memory subsystem configuration. The RAM5500 SPD is software addressable by a unique address.

Clocks

The host board provides one SDRAM clock to the memory expansion connector. The frequency of the RAM5500 CLKS is the same as the host board. This clock is used to generate the on-board SDRAM clocks using a phase lock loop zero delay clock driver.

RAM5500 Module Installation

To upgrade or install a RAM5500 module, refer to and proceed as follows:

1. Attach an ESD strap to your wrist. Attach the other end of the ESD strap to the chassis as a ground. The ESD strap must be secured to your wrist and to ground throughout the procedure.
2. Perform an operating system shutdown. Turn the AC or DC power off and remove the AC cord or DC power lines from the system. Remove the chassis or system cover(s) as necessary for access to the VME boards.
3. Carefully remove the MVME5500 from its VME card slot and lay it flat, with connectors P1 and P2 facing you.
4. Inspect the RAM5500 module that is being installed on the MVME5500 host board to ensure that standoffs are installed in the four mounting holes on the module.
5. With standoffs installed in the four mounting holes on the RAM5500 module, align the standoffs and the P1 connector on the module with

B

the four holes and the P4 connector on the MVME5500 host board and press the two connectors together until they are firmly seated in place.

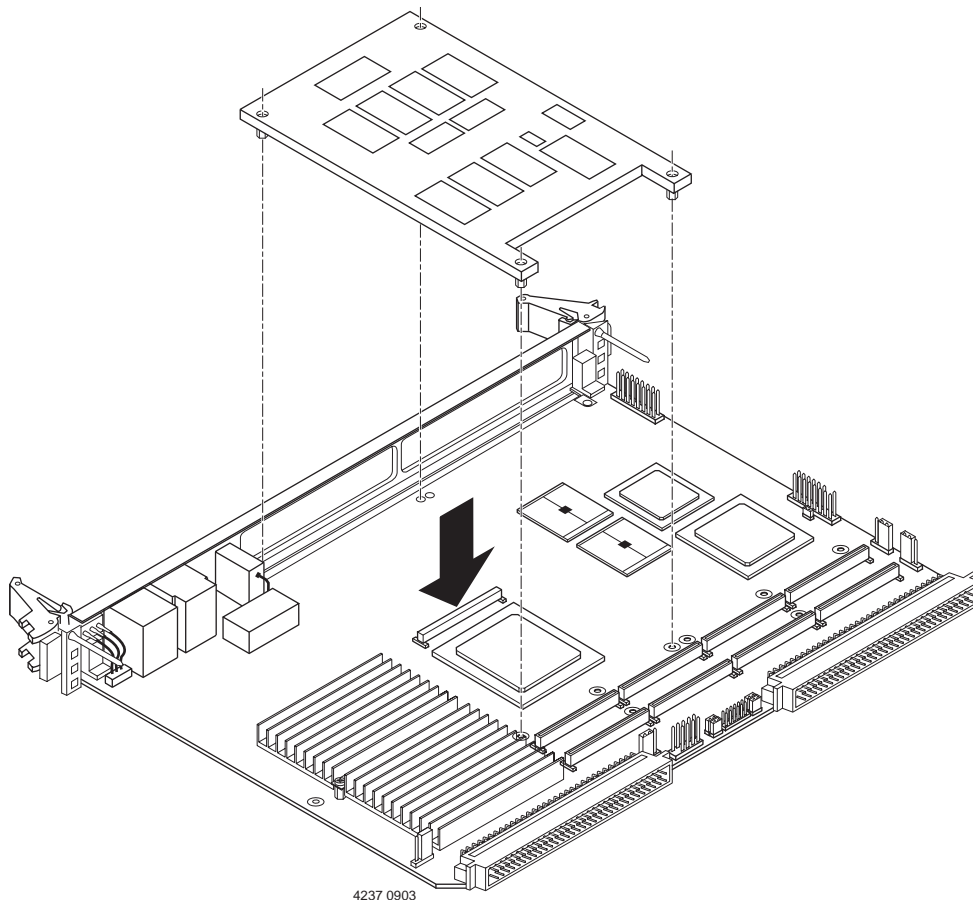

6. Turn the entire assembly over and fasten the four short Phillips screws to the standoffs of the RAM5500.
7. Reinstall the MVME5500 assembly in its proper card slot. Be sure the host board is well seated in the backplane connectors. Do not damage or bend connector pins.
8. Replace the chassis or system cover(s), reconnect the system to the AC or DC power source, and turn the equipment power on.

Memory Expansion Connector (P1) Pin Assignments

The P1 connector on the RAM5500 is a 140-pin AMP 4mm Free Height mating plug. This plug includes common ground contacts that mate with standard AMP receptacle assemblies or AMP GIGA assemblies with ground plates. Refer to *Memory Expansion Connector (P4)* on page 5-29 for the P4 pin assignments.

Table B-2. RAM5500 Connector (P1) Pin Assignments

1	GND*	GND*	2
3	DQ00	DQ01	4
5	DQ02	DQ03	6
7	DQ04	DQ05	8
9	DQ06	DQ07	10
11	+3.3V	+3.3V	12
13	DQ08	DQ09	14
15	DQ10	DQ11	16
17	DQ12	DQ13	18
19	DQ14	DQ15	20
21	GND*	GND*	22
23	DQ16	DQ17	24
25	DQ18	DQ19	26
27	DQ20	DQ21	28
29	DQ22	DQ23	30
31	+3.3V	+3.3V	32
33	DQ24	DQ25	34
35	DQ26	DQ27	36
37	DQ28	DQ29	38

Table B-2. RAM5500 Connector (P1) Pin Assignments

39	DQ30	DQ31	40
41	GND*	GND*	42
43	DQ32	DQ33	44
45	DQ34	DQ35	46
47	DQ36	DQ37	48
49	DQ38	DQ39	50
51	+3.3V	+3.3V	52
53	DQ40	DQ41	54
55	DQ42	DQ43	56
57	DQ44	DQ45	58
59	DQ46	DQ47	60
61	GND*	GND*	62
63	DQ48	DQ49	64
65	DQ50	DQ51	66
67	DQ52	DQ53	68
69	+3.3V	+3.3V	70
71	DQ54	DQ55	72
73	DQ56	DQ57	74
75	DQ58	DQ59	76
77	DQ60	DQ61	78
79	GND*	GND*	80
81	DQ62	DQ63	82
83	CKD00	CKD01	84
85	CKD02	CKD03	86
87	CKD04	CKD05	88
89	+3.3V	+3.3V	90

Table B-2. RAM5500 Connector (P1) Pin Assignments**B**

91	CKD06	CKD07	92
93	BA1	BA0	94
95	A12	A11	96
97	A10	A09	98
99	GND*	GND*	100
101	A08	A07	102
103	A06	A05	104
105	A04	A03	106
107	A02	A01	108
109	+3.3V	+3.3V	110
111	A00	CS_C_L	112
113	CS_D_L	GND*	114
115	DQM8	DQM7	116
117	WE_L	RAS_L	118
119	GND*	GND*	120
121	CAS_L	+3.3V	122
123	+3.3V	DQM6	124
125	DQM5	SCL	126
127	SDA	A1_SPD	128
129	A0_SPD	DQM4	130
131	DQM3	DQM2	132
133	GND	SDRAMCLK1	134
135	GND	+3.3V	136
137	DQM1	DQM0	138
139	GND*	GND*	140

Note *Common GND pins mate to a GIGA assembly with a ground plate. The GIGA assembly is an enhanced electrical performance receptacle and plug from AMP that includes receptacles loaded with contacts for grounding circuits at 9 or 10 signal circuits. These ground contacts mate with grounding plates on both sides of the plug assemblies.

RAM5500 Programming Issues

The RAM5500 contains no user programmable register, other than the SPD data.

Serial Presence Detect (SPD) Data

This register is partially described for the RAM5500 within the *MVME5500 Single Board Computer Programmer's Reference Guide*. The register is accessed through the I2C interface of the GT-64260B on the host board (MVME5500). The RAM5500 SPD is software addressable by a unique address.

Board component temperatures are affected by ambient temperature, air flow, board electrical operation, and software operation. In order to evaluate the thermal performance of a circuit board assembly, it is necessary to test the board under actual operating conditions. These operating conditions vary depending on system design.

While Motorola Computer Group performs thermal analysis in a representative system to verify operation within specified ranges, refer to [Appendix A, Specifications](#), you should evaluate the thermal performance of the board in your application.

This appendix provides systems integrators with information which can be used to conduct thermal evaluations of the board in their specific system configuration. It identifies thermally significant components and lists the corresponding maximum allowable component operating temperatures. It also provides example procedures for component-level temperature measurements.

Thermally Significant Components

The following table summarizes components that exhibit significant temperature rises. These are the components that should be monitored in order to assess thermal performance. The table also supplies the component reference designator and the maximum allowable operating temperature.

You can find components on the board by their reference designators as shown in [Figure C-1](#) and [Figure C-2](#). Versions of the board that are not fully populated may not contain some of these components.

The preferred measurement location for a component may be *junction*, *case*, or *air* as specified in the table. Junction temperature refers to the temperature measured by an on-chip thermal device. Case temperature

refers to the temperature at the top, center surface of the component. Air temperature refers to the ambient temperature near the component.

C

Table C-1. Thermally Significant Components

Reference Designator	Generic Description	Max. Allowable Component Temperature (deg. C)	Measurement Location
U2, U3	Flash, soldered	85	Ambient
U16	Gigabit Ethernet	119	Case
U22	System controller	110	Case
U24	MPC7455 processor	103	Case
U25	VME-to-PCI bridge	70	Ambient
U27	Clock buffer	95	Case
U31	PCI bridge	70	Ambient
U41-43, U45-47, U54-56, U60-62, U64-66, U67-69	SDRAM	85	Case
U123-124	L3 Cache	115	Case

C

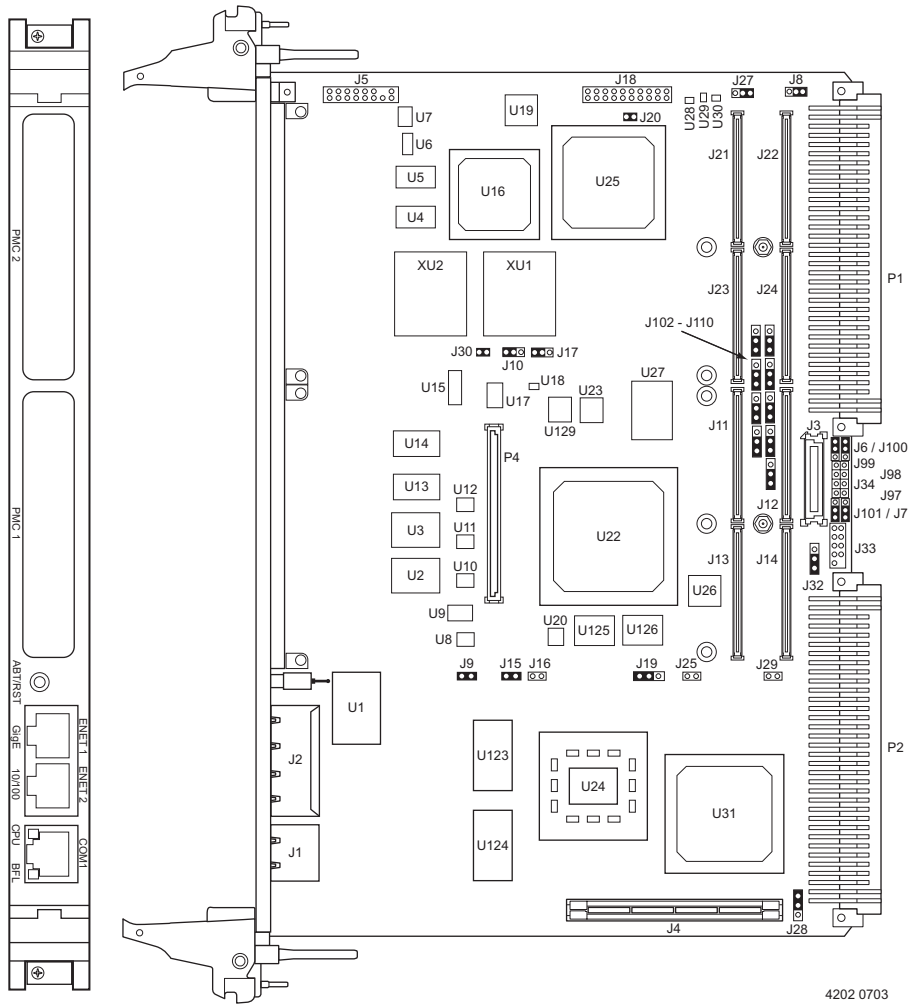

Figure C-1. Thermally Significant Components—Primary Side

C

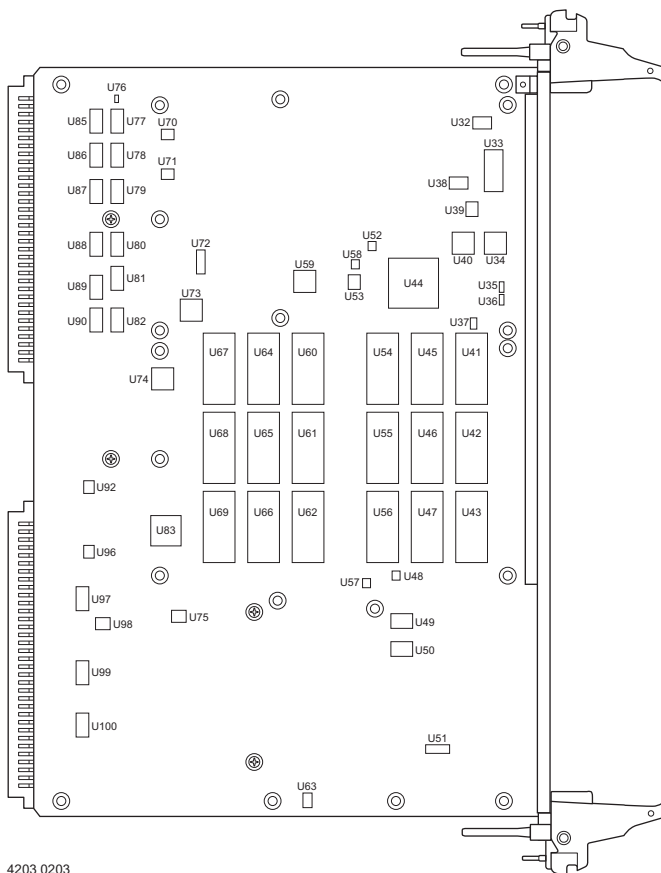

Figure C-2. Thermally Significant Components—Secondary Side

Component Temperature Measurement

The following sections outline general temperature measurement methods. For the specific types of measurements required for thermal evaluation of this board, see [Table C-1](#).

C

Preparation

We recommend 40 AWG (American wire gauge) thermocouples for all thermal measurements. Larger gauge thermocouples can wick heat away from the components and disturb air flowing past the board.

Allow the board to reach thermal equilibrium before taking measurements. Most circuit boards will reach thermal equilibrium within 30 minutes. After the warm up period, monitor a small number of components over time to assure that equilibrium has been reached.

Measuring Junction Temperature

Some components have an on-chip thermal measuring device such as a thermal diode. For instructions on measuring temperatures using the on-board device, refer to the component manufacturer's documentation listed in [Appendix D, Related Documentation](#).

Measuring Case Temperature

Measure the case temperature at the center of the top of the component. Make sure there is good thermal contact between the thermocouple junction and the component. We recommend you use a thermally conductive adhesive such as Loctite 384.

If components are covered by mechanical parts such as heatsinks, you will need to machine these parts to route the thermocouple wire. Make sure that the thermocouple junction contacts *only* the electrical component. Also make sure that heatsinks lay flat on electrical components. The following figure shows one method of machining a heatsink base to provide a thermocouple routing path.

Note Machining a heatsink base reduces the contact area between the heatsink and the electrical component. You can partially compensate for this effect by filling the machined areas with thermal grease. The grease should not contact the thermocouple junction.

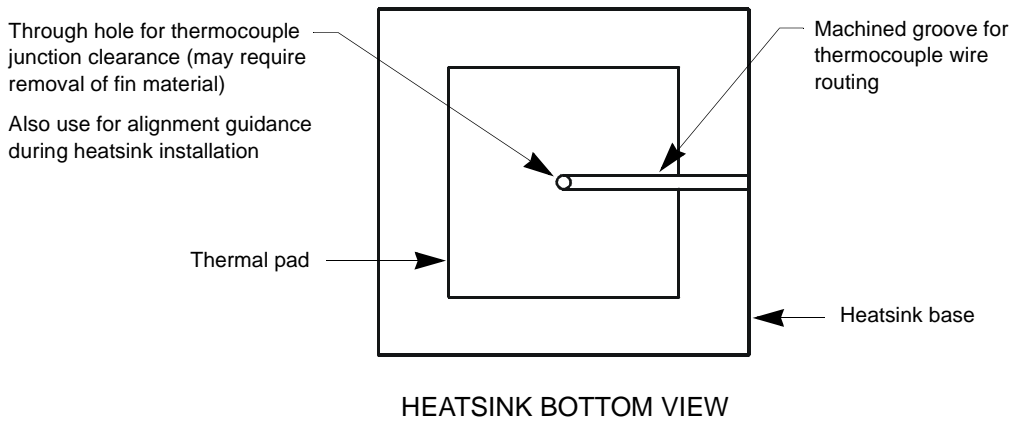
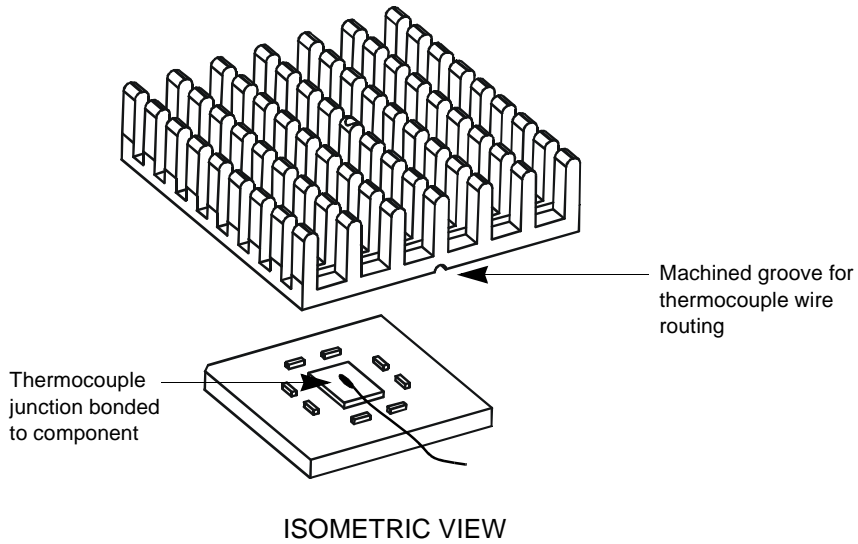

Figure C-3. Mounting a Thermocouple Under a Heatsink

Measuring Local Air Temperature

C

Measure local component ambient temperature by placing the thermocouple downstream of the component. This method is conservative since it includes heating of the air by the component. The following figure illustrates one method of mounting the thermocouple.

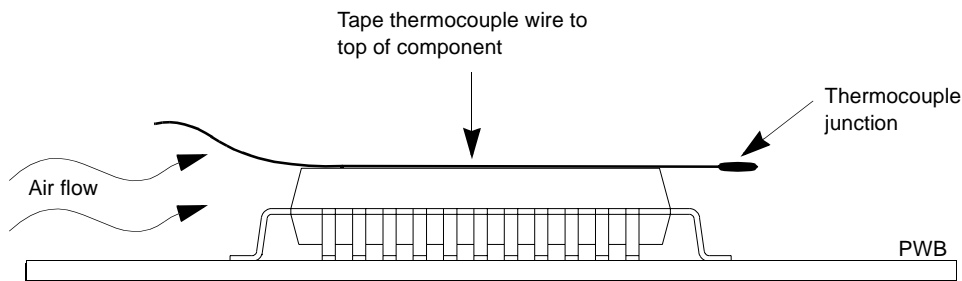

Figure C-4. Measuring Local Air Temperature



Motorola Computer Group Documents

The Motorola publications listed below are referenced in this manual. You can obtain electronic copies of Motorola Computer Group publications by:

- Contacting your local Motorola sales office
- Visiting Motorola Computer Group's World Wide Web literature site, <http://www.motorola.com/computer/literature>

Table D-1. Motorola Computer Group Documents

Document Title	Motorola Publication Number
MVME5500 Single-Board Computer Programmer's Reference Guide	V5500A/PG
MVME761 Transition Module Installation and Use	VME761A/IH
MVME712M Transition Module Installation and Use	VME712MA/IH
MOTLoad Firmware Package User's Manual	MOTLODA/UM
IPMC712/761 I/O Module Installation and Use	VIPMCA/IH
PMCSpan PMC Adapter Carrier Board Installation and Use	PMCSpanA/IH

To obtain the most up-to-date product information in PDF or HTML format, visit <http://www.motorola.com/computer/literature>.

Manufacturers' Documents

For additional information, refer to the following table for manufacturers' data sheets or user's manuals. As an additional help, a source for the listed document is provided. Please note that, while these sources have been verified, the information is subject to change without notice.

Table D-2. Manufacturers' Documents

Document Title and Source	Publication Number
MPC7450 RISC Microprocessor User's Manual Literature Distribution Center for Motorola Telephone: 1-800- 441-2447 FAX: (602) 994-6430 or (303) 675-2150 Web Site: http://e-www.motorola.com/webapp/sps/library/prod_lib.jsp E-mail: ldcformotorola@hibbertco.com	MPC7450UM/D Rev 2
MPC7450 RISC Microprocessor Hardware Specification Literature Distribution Center for Motorola Telephone: 1-800- 441-2447 FAX: (602) 994-6430 or (303) 675-2150 Web Site: http://e-www.motorola.com/webapp/sps/library/prod_lib.jsp E-mail: ldcformotorola@hibbertco.com	MPC7450EC/D Rev 3
GT-64260B System Controller for PowerPC Processors Data Sheet Marvell Technologies, Ltd. Web Site: http://www.marvell.com/	MV-S100414-00B
Intel 82544EI Gigabit Ethernet Controller with Integrated PHY Data Sheet Intel Corporation Literature Center 19521 E. 32nd Parkway Aurora CO 80011-8141 Web Site: http://www.intel.com/design/litcentr/index.htm	82544.pdf

Table D-2. Manufacturers' Documents (continued)

Document Title and Source	Publication Number
LXT971A 10/100Mbit PHY Intel Corporation Literature Center 19521 E. 32nd Parkway Aurora CO 80011-8141 Web Site: http://www.intel.com/design/litcentr/index.htm	
3 Volt Synchronous Intel StrataFlash Memory 28F640K3, 28F640K18, 28F128K3, 28F128K18, 28F256K3, 28F256K18 (x16) Intel Corporation Literature Center 19521 E. 32nd Parkway Aurora CO 80011-8141 Web Site: http://www.intel.com/design/litcentr/index.htm	290737-003
3 Volt Intel StrataFlash Memory 28F128J3A, 28F640J3A, 28F320J3A Intel Corporation Literature Center 19521 E. 32nd Parkway Aurora CO 80011-8141 Web Site: http://www.intel.com/design/litcentr/index.htm	290667-005
PCI 6154 (HB2) PCI-to-PCI Bridge Data Book PLX Technology, Inc. 870 Maude Avenue Sunnyvale, California 94085 Web Site: http://www.hintcorp.com/products/hint/default.asp	6154_DataBook_v2.0.pdf

D

Table D-2. Manufacturers' Documents (continued)

Document Title and Source	Publication Number
TL16C550C Universal Asynchronous Receiver/Transmitter Texas Instruments P. O. Box 655303 Dallas, Texas 75265 Web Site: http://www.ti.com	SLLS177E
3.3V-5V 256Kbit (32Kx8) Timekeeper SRAM ST Microelectronics 1000 East Bell Road Phoenix, AZ 85022 Web Site: http://eu.st.com/stonline/index.shtml	M48T37V
2-Wire Serial CMOS EEPROM Atmel Corporation San Jose, CA Web Site: http://www.atmel.com/atmel/support/	AT24C02 AT24C04 AT24C64 AT24C256 AT24C512
Universe II User Manual Tundra Semiconductor Corporation Web Site: http://www.tundra.com/page.cfm?tree_id=100008#Universe II (CA91C042)	8091142_MD300_01.pdf

D

Related Specifications

For additional information, refer to the following table for related specifications. For your convenience, a source for the listed document is also provided. It is important to note that in many cases, the information is preliminary and the revision levels of the documents are subject to change without notice.

Table D-3. Related Specifications

Document Title and Source	Publication Number
VITA http://www.vita.com/	
VME64 Specification	ANSI/VITA 1-1994
VME64 Extensions	ANSI/VITA 1.1-1997
2eSST Source Synchronous Transfer	VITA 1.5-199x
PCI Special Interest Group (PCI SIG) http://www.pcisig.com/	
Peripheral Component Interconnect (PCI) Local Bus Specification, Revision 2.0, 2.1, 2.2	PCI Local Bus Specification
IEEE http://standards.ieee.org/catalog/	
IEEE - Common Mezzanine Card Specification (CMC) Institute of Electrical and Electronics Engineers, Inc.	P1386 Draft 2.0
IEEE - PCI Mezzanine Card Specification (PMC) Institute of Electrical and Electronics Engineers, Inc.	P1386.1 Draft 2.0

Numerics

10/100Mb Ethernet 4-8

A

abort/reset switch 2-1
air temperature range A-2
ambient temperature, measuring C-8
ambient temperatures C-2
applying power 2-1
asynchronous serial ports 4-10

B

block diagram 4-2
board
 component temperatures C-1
 connectors 1-18
 description 1-1
 dimensions A-2
 installation 1-17
board fail LED 2-1
boundary scan header (J18) 4-12

C

clocks
 RAM5500 B-3
command line rules
 MOTLoad 3-6
comments, sending xix
completing the installation 1-19
connectors, list of 1-18
conventions used in the manual xix
CPU bus activity LED 2-1
CR/CSR settings 3-16

D

debug 4-12
default VME settings 3-12

delete 3-18
display 3-16
edit 3-17
restore 3-18

delete VME settings 3-18
dimensions A-2
display VME settings 3-16
documentation, related D-1

E

edit VME settings 3-17
environmental specifications A-2
ESD precautions 1-3
Ethernet interface
 10/100Mb 4-8
 Gigabit 4-8
evaluating thermal performance C-1
expansion memory B-1

F

features, hardware 4-1
firmware command utility 3-16
Flash memory 4-7

G

Gigabit Ethernet 4-8
GT-64260B 4-4
 CPU bus interface 4-4
 DMA controller 4-6
 I2C serial interface/devices 4-5
 interrupt controller 4-5
 memory controller interface 4-5, B-2
 timers 4-6

H

hardware features 4-1
hardware preparations 1-4

headers, setting 1-5
heatsink, machining C-5
help command
 MOTLoad 3-5
humidity A-2

I

indicators 2-1
install
 MVME5500 1-17
 RAM5500 B-3
installation, completing 1-19

J

jumper settings 1-5, 1-8 to 1-16

L

L3 cache 4-3
LEDs
 board fail 2-1
 CPU bus activity 2-1
LFM A-2
list of commands
 MOTLoad 3-7

M

manual conventions xix
manufacturers' documents D-2
memory
 Flash 4-7
 system 4-7
memory expansion module B-1
 features B-1
 installation B-3
 programming issues B-8
MOTLoad
 command characteristics 3-4
 command line help 3-5
 command line rules 3-6
 command types 3-2
 command versus test 3-2
 described 3-1

 how employed 3-1
 interface 3-4
 list of commands 3-7
 memory requirements 3-1
 prompt explained 3-4
 test suites 3-3
 tests described 3-2
MPC7455 processor 4-3

N

NVRAM 4-10

O

operating temperatures, maximum C-1

P

P1 connector B-5
PCI bus arbitration 4-9
PCI IDSEL signal 4-9
PCI local bus/devices 4-8
PCI-to-PCI bridge 4-9
physical dimensions A-2
PMC expansion connector 4-12
PMC sites 1-16, 4-9
power requirements A-1
power, apply 2-1

R

RAM5500 B-1
 features B-1
 installation B-3
 P1connector B-5
 programming issues B-8
real-time clock (RTC) 4-10
related documentation D-1
relative humidity A-2
reset, sources of 4-11
restore VME settings 3-18

S

serial ports 4-10
serial presence detect B-8
settings, VME 3-12

signalling voltage (Vio) 1-16

sources of reset 4-11

specifications A-2

SROM

RAM5500 B-3

startup overview 1-2

suggestions, submitting xix

switch, abort/reset 2-1

system controller 4-4

CPU bus interface 4-4

DMA controller 4-6

I2C serial interface/devices 4-5

interrupt controller 4-5

memory controller interface 4-5, B-2

timers 4-6

system memory 4-7

T

temperature measurement C-1, C-5

temperature range A-2

temperatures, component C-1

thermal performance C-1

thermocouple, mounting C-7

timer, watchdog 4-10

typeface, meaning of xix

U

Universe II controller 4-11

unpacking guidelines 1-2

V

vibration A-2

Vio keying pin 1-16

VME settings 3-12

delete 3-18

display 3-16

edit 3-17

restore 3-18

vmeCfg 3-16

W

watchdog timer 4-10